

HAEBERLE

mobile workstations

Type list

valid from 1. July 2014

keo[®]

ISO module and functional trolleys
... variable and extraordinary



keo® - the variable and extraordinary ISO module and functional trolleys for medical application

The modern, mobile trolley series with infinite version possibilities and clean lines with colourful accents is ergonomic, perfected suited to its function and practical for many treatment applications. The thoroughly thought-out, practice-orientated organisational system offers free work space.

With the keo® system you are able to create almost any types of functional trolleys in a standardised design for your clinic. With its drawers, ISO-module full-pull-outs or elegant roller blinds, keo® optimally adapts to your furnishing ideas and your modern ambience. Flexible module support walls enable accommodating ISO module baskets of all conventional makes – even at a later date.

keo® as ISO module trolley, anaesthetic trolley, dressing and treatment trolley, emergency trolley ... and more

System:

- A rugged, torsionally stiff sheet metal construction of galvanized, high-quality, coated sheet metal. Resistant to disinfectants, easy to clean and light-resistant. Free of drumming due to single-tray construction. Very low weight!
- 4 elegant, anodised aluminium support profiles for mounting accessories. Subsequent mounting of accessories is also possible.
- An elegant, anodised aluminium push handle is standard.
- All module full-pull-outs are provided with an inset frame suitable for all conventional ISO module baskets. The pull-out is extendable up to approx. 110%, so that the module contents are comfortably and easily removable.
- Drawers are equipped also with full-pull-outs (110%).
- Inset frames and drawers with ball bearing telescopic slide-out with self pull-in for easy gliding and comfortable use.
- High-quality, Ø 125 mm, smoothly-running castors with 2 brakes and with wall guards are standard. Electrically conductive castors are available at an additional price.
- Total load of the trolleys up to approx. 130 kg.

Colours:

Trolley colours: grey white RAL 9002, night-blue RAL 5022, white aluminium RAL 9006. Drawer handles, module full-pull-out handles and decorative strips are available in grey, blue, red violet, yellow and turquoise. Decorative strips also in night-blue colour.

On request we offer you the trolleys also with full varnishing in all RAL colours!

Dimensions:

Case width: (incl. wall guards)..... 770 mm
 Case depth: (incl. wall guards)..... 580 mm
 Case height, (incl. castors)..... 913/1.041/1.169 mm
 Overall width (incl. 1 push handle and wall guards).... 800 mm

Item	Description	Ref. no.
------	-------------	----------

In your order please specify the colour code by adding it as the last digit to the reference number. The following colour combinations are possible:

- xxxx1 = trolley grey white RAL 9002, handles and decorative strips grey
- xxxx2 = trolley grey white RAL 9002, handles and decorative strips blue
- xxxx3 = trolley grey white RAL 9002, handles and decorative strips red violet
- xxxx4 = trolley grey white RAL 9002, handles and decorative strips yellow
- xxxx5 = trolley grey white RAL 9002, handles and decorative strips turquoise
- xxxx6 = trolley night-blue RAL 5022, handles white aluminium RAL 9006, decorative strips night-blue RAL 5022
- xxxx7 = trolley white aluminium RAL 9006, handles and decorative strips grey

Other RAL Classic colour combinations on request.

Functional trolleys for ISO modules

Recommended combinations, which can be supplemented or altered whenever necessary. All functional trolleys are delivered fully assembled at no additional cost. The price includes the elegant push handle Suitable system parts and accessories for the keo®-trolleys you will find up from page 8.

ISO module trolleys

The keo® ISO module trolleys are suitable for all conventional ISO module systems. You have the choice between the more comfortable module full-pull-out frames, which can be extended to 110%, or module support walls. We have compiled a selection of functional trolleys for you. Using the various system and accessory components you can at any time put together your own special model customized to your requirements. The **modules are not included** in the presented module trolleys. You can use your own module stocks or purchase modules from us (page 14).

ISO module trolley 1



ABS-plastic work surface with a four-sided raised edge, 5 ISO module full-pull-outs (110%) for supporting 50 or 100 mm high ISO modules.

4 castors Ø 125 mm with 2 brakes and wall guards, 1 push handle.

Dim.: 800 x 580 x 990 mm (w x d x h) 1851

ISO module trolley 3



ABS-plastic work surface with a four-sided raised edge, aluminium coloured roller blind with lock and handle, 2 ISO-support walls for 4 ISO modules, 100 - 110 mm.

4 castors Ø 125 mm with 2 brakes and wall guards, 1 push handle.

Dim.: 800 x 580 x 990 mm (w x d x h) 1853

ISO module trolley 4



ABS-plastic work surface with a four-sided raised edge, aluminium coloured roller blind with lock and handle, 2 ISO-support walls for 5 ISO modules, 100 - 110 mm, 1 drawer 125, 1 standard profile rail made of stainless steel.

4 castors Ø 125 mm with 2 brakes and wall guards, 1 push handle.

Dim.: 800 x 580 x 1.244 mm (w x d x h) 1895

Item	Description	Ref. no.
------	-------------	----------

ISO module trolleys

ISO module trolley 5



ABS-plastic work surface with a four-sided raised edge, 3 ISO module full-pull-outs (110%) for supporting 50 or 100 mm high ISO modules, 2 module full-pull-outs for supporting 200 mm high ISO modules.

4 castors Ø 125 mm with 2 brakes and wall guards, 1 push handle.

Dim.: 800 x 580 x 1.242 mm (w x d x h) 1855

ISO module trolley 6



ABS-plastic work surface with a four-sided raised edge, aluminium coloured roller blind with lock and handle, 2 ISO-support walls for 7 ISO modules.

4 castors Ø 125 mm with 2 brakes and wall guards, 1 push handle.

Dim.: 800 x 580 x 1.242 mm (w x d x h) 1856

ISO module trolley 7

new



Case in special size, roller blind made of high-quality plastic (aluminium coloured) with lock and handle, 2 ISO-support walls for 12 ISO modules 600 x 400 x 100 mm (w x d x h).

4 castors Ø 125 mm with 2 brakes and wall guards, 1 push handle.

Dim.: 600 x 780 x 1.810 mm (w x d x h) 1899

ISO module trolley 8

new



Case in special size, roller blind made of high-quality plastic (aluminium coloured) with lock and handle, 2 ISO-support walls for 12 ISO modules 600 x 400 x 100 mm (w x d x h).

4 castors Ø 125 mm with 2 brakes and wall guards, 1 push handle.

Dim.: 800 x 580 x 1.810 mm (w x d x h) 1898

Item	Description	Ref. no.
------	-------------	----------

ISO anaesthetic trolleys

ISO anaesthetic trolley 1



ABS-plastic work surface with a four-sided raised edge with insertion stainless steel plate, 7 module full-pull-outs (110%) for supporting 50 or 100 mm high modules.

4 castors Ø 125 mm with 2 brakes and wall guards, 1 push handle.

Dim.: 800 x 580 x 1.242 mm (w x d x h) 1861

ISO anaesthetic trolley 2



ABS-plastic work surface with a four-sided raised edge with insertion stainless steel plate, 3 module full-pull-outs (110%) for supporting 50 or 100 mm high modules. 2 module full-pull-outs (110%) for supporting 200 mm high ISO-modules.

4 castors Ø 125 mm with 2 brakes and wall guards, 1 push handle.

Dim.: 800 x 580 x 1.242 mm (w x d x h) 1862

ISO anaesthetic trolley 3



ABS-plastic work surface with a four-sided raised edge with insertion stainless steel plate and side extension (metal), 3 module full-pull-outs (110%) for supporting 50 or 100 mm high ISO modules, 1 module full-pull-out (110%) for supporting a 200 mm high ISO module.

4 castors Ø 125 mm with 2 brakes and wall guards, 1 push handle.

Dim.: 800 x 580 x 990 mm (w x d x h) 1863

ISO module dressing and treatment trolleys

Treat yourself to clear work spaces. The organisation system allows you to compactly store all common material packages and leaves the work surface free for your preparations. Two capacious, tilted deposit levels provided with adjustable clips provide room for all types of packages. Ergonomical placement, variable equipping. Work is a pleasure using the intelligently shaped and easy to clean work surface with its rounded corners.

ISO dressing and treatment trolley 3



organisation system with 2 tilted deposit levels and 10 clips, ABS-plastic work surface with a four-sided raised edge, aluminium coloured roller blind with lock and handle, 2 ISO-support walls for 4 ISO modules.

4 castors Ø 125 mm with 2 brakes and wall guards, 1 push handle.

Dim.: 800 x 580 x 1.628 mm (w x d x h) 1864

Item	Description	Ref. no.
------	-------------	----------

ISO module dressing and treatment trolleys

ISO dressing and treatment trolley 4



PicBox® injection set, with 3 large and 5 small boxes, ABS-plastic work surface with a four-sided raised edge, aluminium coloured roller blind with lock and handle, 2 ISO-support walls for 4 ISO modules, 100 - 110 mm.

4 castors Ø 125 mm with 2 brakes and wall guards, 1 push handle.

Dim.: 800 x 580 x 1.628 mm (w x d x h) 1865

ISO dressing and treatment trolley 5



organisation system with 1 deposit level plus 5 clips, PicBox® canula dispenser with 5 small boxes, ABS-plastic work surface with a four-sided raised edge and extendable pull-out plate, aluminium coloured roller blind with lock and handle, 2 ISO-support walls for 4 ISO modules, 100 - 110 mm.

4 castors Ø 125 mm with 2 brakes and wall guards, 1 push handle.

Dim.: 800 x 580 x 1.628 mm (w x d x h) 1866

ISO dressing and treatment trolley 7



PicBox® injection set with 3 large and 5 small boxes, ABS-plastic work surface with a four-sided raised edge extendable pull-out plate. 4 ISO module full-pull-outs 125, 1 ISO module full-pull-out 250, 1 waste collector "tango" with knee operation (20 ltrs.).

4 castors Ø 125 mm with 2 brakes and wall guards, 1 push handle.

Dim.: 960 x 580 x 1.628 mm (w x d x h) 1881

(width with waste collector)

ISO dressing and treatment trolley 8

new



PicBox® injection set with 3 large and 5 small boxes, ABS-plastic work surface with a four-sided raised edge and extendable pull-out plate. 4 ISO module full-pull-outs 125, 1 ISO module full-pull-out 250, 1 "tomo" waste collector,

4 castors Ø 125 mm with 2 brakes and wall guards, 1 push handle.

Dim.: 934 x 580 x 1.628 mm (w x d x h) 1761

(width with waste collector)

Item	Description	Ref. no.
------	-------------	----------

ISO module emergency trolleys

These emergency trolleys do not include modules. You can use your own module stocks or purchase modules from us.

ISO emergency trolley 1



300 mm deep tray console with anti-slide mat for defibrillators and other devices, ABS-plastic work surface with a four-sided raised edge, 3 ISO module full-pull-outs (110%) for supporting 50 or 100 mm high ISO modules. 1 module full-pull-out (110%) for supporting a 200 mm high ISO module,

4 castors Ø 125 mm, electrically conductive with 2 brakes and wall guards, 1 push handle.

Dim.: 800 x 607 x 1.180 mm (w x d x h) 1857

ISO emergency trolley 2



300 mm deep tray console with anti-slide mat for defibrillators and other devices, ABS-plastic work surface with a four-sided raised edge, 3 ISO module full-pull-outs (110%) for supporting 50 or 100 mm high ISO modules, 1 open compartment, 255 mm high, with anti-slide mat,

4 castors Ø 125 mm, electrically conductive with 2 brakes and wall guards, 1 push handle.

Dim.: 800 x 607 x 1.180 mm (w x d x h) 1858

Functional trolleys with metal drawers

If you prefer drawers instead of ISO modules, we recommend the following keo® models. All drawers have a very comfortable 110% pull-out feature. You can also mix module full-pull-outs and drawers and configure system and accessory units to suit your individual purposes. We will be glad to assist you.

Treatment trolley 5



Metal work surface, powder-coated, grey-white RAL 9002, with extendable pull-out plate, powder-coated metal, white aluminium RAL 9006, 1 drawer 125, 1 drawer 250, 1 filing cabinet (DIN A4) with lock

4 castors Ø 125 mm with 2 brakes and wall guards, 1 push handle.

Dim.: 800 x 580 x 1.038 mm (w x d x h) 1897

Treatment trolley 6



organisation system with 1 special steel deposit level with 5 clips, PicBox® canula dispenser with 5 small boxes, ABS-plastic work surface with a four-sided raised edge and extendable pull-out plate, 1 drawer 125, 1 drawer 250, 1 filing cabinet (DIN A4) with lock, soap and disinfectant dispenser, Medi-Müll set with 20 boxes and mounting, standard profile rail, infusion bottle holder, central locking and push handle ref. no. 20061 with label window,

4 castors Ø 125 mm with 2 brakes and wall guards, 1 push handle.

Maße: 800 x 580 x 1.038 mm (B x T x H) 1868

Item	Description	Ref. no.
------	-------------	----------

Functional trolleys with metal drawers

Dressing and treatment trolley 1



ABS-plastic work surface with a four-sided raised edge, 5 drawers, each 125 mm high, with full-pull-outs (110%).
Inside dim.: 570 x 395 x 92 mm (w x d x h)

4 castors Ø 125 mm with 2 brakes and wall guards, 1 push handle.

Dim.: 800 x 580 x 990 mm (w x d x h) **1832**

Dressing and treatment trolley 2



ABS-plastic work surface with a four-sided raised edge, 7 drawers, each 125 mm high, with full-pull-outs (110%).
Inside dim.: 570 x 395 x 92 mm (w x d x h)

4 castors Ø 125 mm with 2 brakes and wall guards, 1 push handle.

Dim.: 800 x 580 x 1.242 mm (w x d x h) **1838**

Anaesthetic trolley 1



ABS-plastic work surface with a four-sided raised edge with insertion stainless steel plate, 5 drawers with full-pull-outs (110%), each 125 mm high.
Inside dim.: 570 x 395 x 92 (w x d x h)

4 castors Ø 125 mm with 2 brakes and wall guards, 1 push handle.

Dim.: 800 x 580 x 990 mm (w x d x h) **1859**

Anaesthetic trolley 2



ABS-plastic work surface with a four-sided raised edge, insertion stainless steel plate, 3 drawers, each 125 mm high, with full-pull-outs (110%), inside dim.: 570 x 395 x 92 (w x d x h), 1 drawer, 250 mm high, with full-pull-out (110%).
Inside dim.: 570 x 395 x 220 (w x d x h)

4 castors Ø 125 mm with 2 brakes and wall guards, 1 push handle.

Dim.: 800 x 580 x 990 mm (w x d x h) **1860**

System parts – individually according to you requirements

Castors

Castors







surcharge for 4 castors Ø 125 mm, smoothly-running and **electrically conductive** with wall guards and 2 brakes.

18064

Item	Description	Ref. no.
------	-------------	----------

Cases / Roller blind / Module support walls

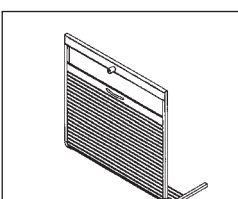
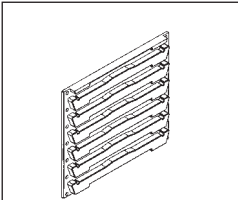
<p>Case for 5 height grids</p>		<p>with 4 Ø 125 mm, smoothly-running castors, wall guards and 2 brakes.</p> <p>Dim.: 770 x 580 x 913 mm (w x d x h) 1818 <input type="checkbox"/></p>
<p>Case for 6 height grids</p>		<p>with 4 Ø 125 mm, smoothly-running castors, wall guards and 2 brakes.</p> <p>Dim.: 770 x 580 x 1.041 mm (w x d x h) 1879 <input type="checkbox"/></p>
<p>Case for 7 height grids</p>		<p>with 4 Ø 125 mm, smoothly-running castors, wall guards and 2 brakes.</p> <p>Dim.: 770 x 580 x 1.169 mm (w x d x h) 1819 <input type="checkbox"/></p>
<p>Case for 5 height grids</p>		<p>with extended profile supports (at rear), to support the organisation system or PicBox® sets, or similar articles, with 4 Ø 125 mm, smoothly-running castors, wall guards and 2 brakes.</p> <p>Dim.: 770 x 580 x 1.628 mm (w x d x h) 1841 <input type="checkbox"/></p>
<p>Roller blind with 2 ISO module support walls</p>	 	<p>Roller blind made of high-quality plastic, aluminium coloured with lock and handle, easy to clean. ISO module support walls made of grey plastic (ABS) to insert ISO modules 600 x 400 mm (w x d). The ref.no. include the roller blind with ISO module support walls (right and left side)</p> <p>for 4 ISO modules, 100 - 110 mm high suitable for case for 5 height grids 18844 (ref.no. 18181.-.7 or 1841.1.-.7)</p> <p>for 5 ISO modules, 100 - 110 mm high suitable for case for 6 height grids 18845 (ref.no. 1879.1.-.7)</p> <p>for 7 ISO modules, 100 - 110 mm high suitable for case for 7 height grids 18846 (ref.no. 1819.1.-.7)</p> <p>The installation of a drawer or an ISO module full-pull-out 125 reduced the number of deployable ISO modules.</p> <p>If you use different heights of ISO modules you can put in more or less ISO modules. Please contact our team of consultants.</p>

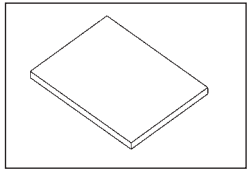
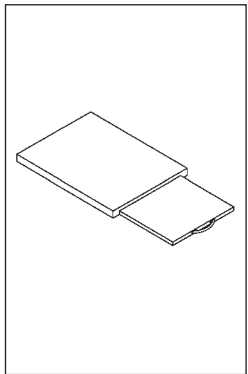
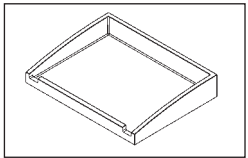
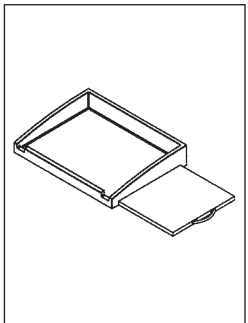
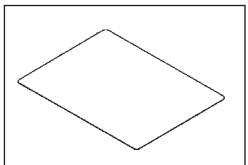
Item	Description	Ref. no.
Work surfaces / Panel board		
Work surface metall		<p>powder-coated metal, grey-white RAL 9002 night-blue RAL 5022 white aluminium RAL 9006</p> <p>Dim.: 634 x 485 x 40 mm (w x d x h)</p> <p>18091 18093 18092</p>
Work surface metall with pull-out plate		<p>Work surface, powder-coated metal</p> <p>Dim.: 634 x 485 x 40 mm (w x d x h)</p> <p>Pull-out plate, metal white aluminium powder-coated, RAL 9006, extendable on right-hand side drawing distance: 340 mm, load capacity up to 10 kg</p> <p>Dim.: 376 x 432 x 16 mm (w x d x h)</p> <p>Work surface: grey-white RAL 9002, Handle colour:</p> <p>grey 18071 blue 18072 violet red 18073 yellow 18074 turquoise 18075</p> <p>Work surface night-blue RAL 5022 handle colour: white aluminium 18076</p> <p>Work surface white aluminium RAL 9006 handle colour: grey 18077</p> <p>If a central locking or anti-tamper seal (ref. no. 18432) is mounted, the extension is only possible to the left side.</p>
Work surface ABS-plastic		<p>grey ABS-plastic, with a raised edge on 4 sides</p> <p>Dim.: 634 x 484 x 110 mm (w x d x h) 18097</p>
Work surface ABS-plastic with pull-out plate		<p>Work surface grey ABS-plastic, with a raised edge on 4 sides</p> <p>Dim.: 634 x 484 x 110 mm (w x d x h)</p> <p>Pull-out plate, metal white aluminium powder-coated, RAL 9006, extendable on right-hand side, drawing distance: 340 mm, load capacity up to 10 kg</p> <p>Dim.: 376 x 432 x 16 mm (w x d x h)</p> <p>Handle colour:</p> <p>grey 18461 blue 18462 violet red 18463 yellow 18464 turquoise 18465 white aluminium 18466</p> <p>If a central locking or anti-tamper seal (ref. no. 18432) is mounted, the extension is only possible to the left side.</p>
Panel board		<p>made of stainless steel for work surface with a raised edge on 4 sides.</p> <p>Dim.: 584 x 435 x 1 mm (w x d x h) 18128</p>

Item	Description	Ref. no.
------	-------------	----------

Work surface / Cover plate / Tray console / Pull-out plate for notebook / Folding console

**work surface
stainless steel with
a beaded edge**

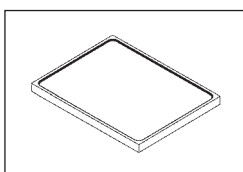

rugged due to the pattern-rolled surface structure.

Dim.: 634 x 484 x 40 mm (w x d x h) **18095**

Cover plate

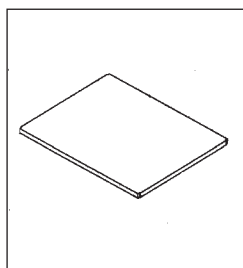

to cover drawers or module full-pull-outs,
powder-coated metal.

Dim.: 628 x 482 x 20 mm (w x d x h)
grey-white **18467**
night-blue **18468**
white aluminium **18469**

Tray console

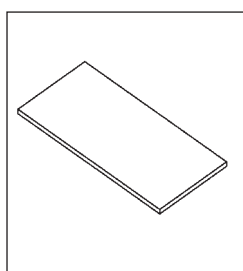

powder-coated metal.

Dim.: 634 x 300 x 20 mm (w x d x h)
grey-white RAL 9002 **18061**
night-blue RAL 5022 **18063**
white aluminium RAL 9006 **18062**

**Pull-out plate
for notebook**

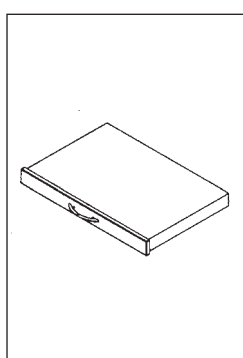

extensible to the front, mounted on full-pull-out (110%).

Dim.: 602 x 400 x 61 mm (w x d x h)
Shelf: grey-white, RAL 9002,
Handle colour:
grey **18500**
blue **18503**
violet red **18504**
yellow **18505**
turquoise **18506**
night-blue RAL 5022
handle colour white aluminium **18501**
white aluminium RAL 9006
handle colour grey **18502**





**Folding console
slide**

new

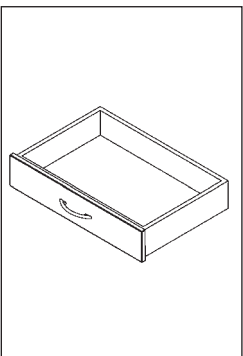
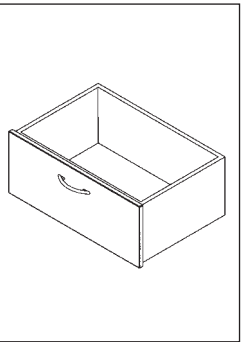

Height-adjustable and foldable white console
for lateral fastening to keo®. Easy folding with
spring-mounted lock. Convenient height adjustment
with locking bolt. Plate made of sheet steel,
grey-white (RAL 9002), powder-coated. Throat
depth 477 mm, folded 76 mm, max. load 10 kg.

Dim: 450 x 450 mm (w xd)
for keo® **14205**

Item	Description	Ref. no.										
Drawers / Drawer inset / Handles / Module for notebook												
Drawer 125		<p>with full-pull-out (110%), height 125 mm. Inside dim.: 570 x 395 x 92 mm (w x d x h)</p> <p>Drawer: grey-white, RAL 9002, Handle colour:</p> <table border="0"> <tr><td>grey</td><td style="text-align: right;">18121</td></tr> <tr><td>blue</td><td style="text-align: right;">18122</td></tr> <tr><td>violet red</td><td style="text-align: right;">18123</td></tr> <tr><td>yellow</td><td style="text-align: right;">18124</td></tr> <tr><td>turquoise</td><td style="text-align: right;">18125</td></tr> </table> <p>Drawer: night-blue RAL 5022 Handle colour: white aluminium 18126</p> <p>Drawer: white aluminium RAL 9006 Handle colour: grey 18127</p>	grey	18121	blue	18122	violet red	18123	yellow	18124	turquoise	18125
grey	18121											
blue	18122											
violet red	18123											
yellow	18124											
turquoise	18125											
Drawer 250		<p>with full-pull-out (110%), height 250 mm. Inside dim.: 570 x 395 x 220 mm (w x d x h)</p> <p>Drawer: grey-white RAL 9002, Handle colour</p> <table border="0"> <tr><td>grey</td><td style="text-align: right;">18131</td></tr> <tr><td>blue</td><td style="text-align: right;">18132</td></tr> <tr><td>violet red</td><td style="text-align: right;">18133</td></tr> <tr><td>yellow</td><td style="text-align: right;">18134</td></tr> <tr><td>turquoise</td><td style="text-align: right;">18135</td></tr> </table> <p>Drawer: night-blue RAL 5022 Handle colour: white aluminium 18136</p> <p>Drawer: white aluminium RAL 9006 Handle colour: grey 18137</p>	grey	18131	blue	18132	violet red	18133	yellow	18134	turquoise	18135
grey	18131											
blue	18132											
violet red	18133											
yellow	18134											
turquoise	18135											
Drawer inset		<p>with variable partitions and flexible dividers for keo® with lengthways dividers and crossways dividers. Made of transparent synthetic material, removable and suitable for cleaning in the dishwasher</p> <table border="0"> <tr><td>for drawer 125</td><td style="text-align: right;">17363</td></tr> <tr><td>for drawer 250</td><td style="text-align: right;">17364</td></tr> </table>	for drawer 125	17363	for drawer 250	17364						
for drawer 125	17363											
for drawer 250	17364											
Push handle		<p>anodised aluminium, white aluminium RAL 9006, length approx. 470 mm 17942</p>										
Drawer handle		<p>with label window, made of ABS plastic, grey 20061</p>										
Module for notebook with lock		<p>sidewards-extendable and mountable on the left or right side</p> <p>Dim.: 485 x 634 x 128 mm (w x d x h)</p> <p>Module for notebook: grey-white RAL 9002, Handle colour:</p> <table border="0"> <tr><td>grey</td><td style="text-align: right;">18921</td></tr> <tr><td>blue</td><td style="text-align: right;">18922</td></tr> <tr><td>violet red</td><td style="text-align: right;">18923</td></tr> <tr><td>yellow</td><td style="text-align: right;">18924</td></tr> <tr><td>turquoise</td><td style="text-align: right;">18925</td></tr> </table> <p>Module for notebook: night-blue RAL 5022 Handle colour: white aluminium 18926</p> <p>Module for notebook: white aluminium RAL 9006 Handle colour: grey 18927</p>	grey	18921	blue	18922	violet red	18923	yellow	18924	turquoise	18925
grey	18921											
blue	18922											
violet red	18923											
yellow	18924											
turquoise	18925											

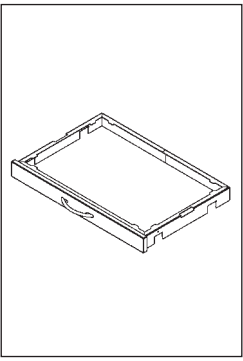
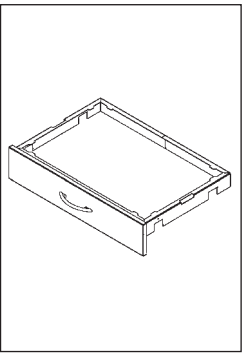
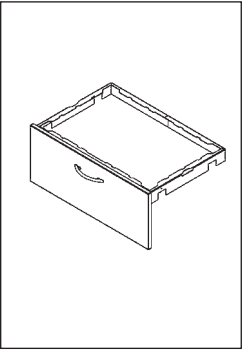
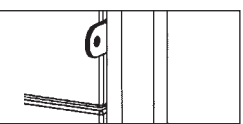
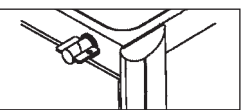

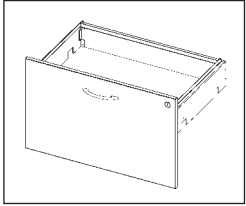

Item	Description	Ref. no.										
Module full-pull-outs / Pull-out stop / Central locking / Sealing												
Module full-pull-out 61		<p>to support 50 mm high ISO modules, extendable by 110% to enable easy removal of the ISO module, 61 mm height.</p> <p>Dim.: 622 x 418 x 61 mm (w x d x h)</p> <p>Module full-pull-out: grey-white RAL 9002, Handle colour:</p> <table border="0"> <tr><td>grey</td><td>18441</td></tr> <tr><td>blue</td><td>18442</td></tr> <tr><td>violet red</td><td>18443</td></tr> <tr><td>yellow</td><td>18444</td></tr> <tr><td>turquoise</td><td>18445</td></tr> </table> <p>Module full-pull-out: night-blue RAL 5022 Handle colour: white aluminium 18446</p> <p>Module full-pull-out: white aluminium RAL 9006 Handle colour: grey 18447</p>	grey	18441	blue	18442	violet red	18443	yellow	18444	turquoise	18445
grey	18441											
blue	18442											
violet red	18443											
yellow	18444											
turquoise	18445											
Module full-pull-out 125		<p>to support 50 or 100 mm high ISO modules, extendable by 110% to enable easy removal of the ISO module, 125 mm height.</p> <p>Dim.: 622 x 418 x 125 mm (w x d x h)</p> <p>Module full-pull-out: grey-white RAL 9002, Handle colour:</p> <table border="0"> <tr><td>grey</td><td>18141</td></tr> <tr><td>blue</td><td>18142</td></tr> <tr><td>violet red</td><td>18143</td></tr> <tr><td>yellow</td><td>18144</td></tr> <tr><td>turquoise</td><td>18145</td></tr> </table> <p>Module full-pull-out: night-blue RAL 5022 Handle colour: white aluminium 18146</p> <p>Module full-pull-out: white aluminium RAL 9006 Handle colour: grey 18147</p>	grey	18141	blue	18142	violet red	18143	yellow	18144	turquoise	18145
grey	18141											
blue	18142											
violet red	18143											
yellow	18144											
turquoise	18145											
Module full-pull-out 250		<p>to support 200 mm high ISO modules, extendable by 110% to enable easy removal of the ISO module, 250 mm height.</p> <p>Dim.: 622 x 418 x 250 (w x d x h)</p> <p>Module full-pull-out: grey-white RAL 9002, Handle colour:</p> <table border="0"> <tr><td>grey</td><td>18151</td></tr> <tr><td>blue</td><td>18152</td></tr> <tr><td>violet red</td><td>18153</td></tr> <tr><td>yellow</td><td>18154</td></tr> <tr><td>turquoise</td><td>18155</td></tr> </table> <p>Module full-pull-out: night-blue RAL 5022 Handle colour: white aluminium 18156</p> <p>Module full-pull-out: white aluminium RAL 9006 Handle colour: grey 18157</p>	grey	18151	blue	18152	violet red	18153	yellow	18154	turquoise	18155
grey	18151											
blue	18152											
violet red	18153											
yellow	18154											
turquoise	18155											
Pull-out stop		<p>for drawers and module full-pull-outs. When one e.g. drawer is opened, all others are locked</p> <p>18437</p>										
Central locking		<p>for 2-5 drawers or module full-pull-outs 18440 for 6-7 drawers or module full-pull-outs 18438 incl. pull-out stop</p>										
Sealing	 	<p>for 1 pull-out, without single use seals 17797</p> <p>for several pull-outs, without single use seals 18432 incl. pull-out stop</p>										
Single use seals		<p>made of blue plastic, per 100 13998</p>										





Item	Description	Ref. no.
Filing cabinet		
Filing cabinet	forward-extendable, (DIN A 4) with lock	
	Dim.: 622 x 416 x 381 mm (w x d x h)	
	Filing cabinet: grey-white RAL 9002,	
	Handle colour:	
	grey	18931
	blue	18932
	violet red	18933
	yellow	18934
	turquoise	18935
	Filing cabinet: night-blue RAL 5022	
	Handle colour: white aluminium	18936
	Filing cabinet: white aluminium RAL 9006	
	Handle colour: grey	18937

Accessories

The reference numbers of the accessories specify the accessory and include the assembly material, if applicable. The price includes assembly. However, it is also possible to retrofit accessories to the trolleys.

The ISO modules with variable module divisions offer universal ranges of application, optimal place use and variability by flexible module dividers. By a clip-on-effect the module divisions (cross-dividers) get quickly connected to the modules. They can be adjusted every 10 mm alternatively 20 mm. The ISO modules and module divisions are mar-resistant, pollutant freely recyclable and resistant to the usual cleaning and disinfectants. Cleaning in the dishwasher at 65 degrees Celsius.

ISO modules		ABS grey (Acrylnitril-Butadien-Styrol)	
		Dim.: 600 x 400 x 50 mm (w x d x h)	18898
		Dim.: 600 x 400 x 100 mm (w x d x h)	18896
		Dim.: 600 x 400 x 200 mm (w x d x h)	18897
Module divisions for ISO modules		transparent acrylic (Polycarbonat)	
		for transverse divisions	
		Dim.: 400 x 50 mm (l x h)	18908
		for ISO modules 600 x 400 x 50 (w x d x h)	
		Dim.: 400 x 100 mm (l x h)	18892
		for ISO modules 600 x 400 x 100 (w x d x h)	
		Dim.: 400 x 200 mm (l x h)	18893
		for ISO modules 600 x 400 x 200 (w x d x h)	
Module divisions for ISO modules		transparent acrylic (Polycarbonat)	
		for transverse divisions	
		Dim.: 600 x 50 mm (l x h)	18899
		for ISO modules 600 x 400 x 50 (w x d x h)	
		Dim.: 600 x 100 mm (l x h)	18891
		for ISO modules 600 x 400 x 100 (w x d x h)	
		Dim.: 600 x 200 mm (l x h)	18894
		for ISO modules 600 x 400 x 200 (w x d x h)	
ISO module medication dispenser		blue, made of polystyrene, suitable for ISO module pull-out and trolleys with roller blind. Medication dispenser for 7 days, each with sliding lid and 4 movable dividers (up to 10 compartments dividable).	18400
new		Dim. tray: 600 x 400 x 30 mm (w x d x h)	
		Dim.: dispenser: 80 x 370 x 30 mm (w x d x h)	

Item	Description	Ref. no.
alegro monitor holder		<p>on tightly adjusted column (height above the profile approx. 400 mm). Steplessly and precisely fixation without any physical exertion. Horizontally and vertically rotatable, tilting and swivelling function.</p> <p>Monitor adaption VESA 75/100</p> <p>Load capacity up to 12 kg 25017</p> <p>Load capacity up to 18 kg 25043</p>
alegro monitor holder on swivel arm		<p>with 2 hinge joints and integrated cable duct. Steplessly and precisely fixation without any physical exertion. Horizontally and vertically rotatable, tilting and swivelling function. Reach 300 mm.</p> <p>Monitor adaption VESA 75/100</p> <p>Load capacity up to 12 kg 25022</p> <p>Load capacity up to 18 kg 25048</p>
alegro holder for double monitoring		<p>on aluminium-traverse (w 600 mm) between two carrier profiles. Steplessly and precisely fixation without any physical exertion. Horizontally and vertically rotatable, tilting and swivelling function for precise synchronic adjustment, cable duct inside the profiles.</p> <p>Monitor adaption VESA 75/100</p> <p>Load capacity up to 2 x 12 kg 25016</p> <p>Load capacity up to 2 x 18 kg 25042</p>
alegro monitor holder		<p>on aluminium-traverse (w 600 mm) between two carrier profiles. Steplessly exact fixation without any physical exertion. Horizontally and vertically rotatable, tiltable and pivotable. Cable duct inside the profiles.</p> <p>Monitor adaption VESA 75/100</p> <p>Load capacity up to 12 kg 25058</p> <p>Load capacity up to 18 kg 25059</p>
Waste collector tomo new		<p>made of smooth and easy to clean plastic (100% polypropylene), grey RAL 7045, with detachable, well closing lid and with mount. Capacity 10 litres (for disposable bags approx. w 450 x h 350 mm).</p> <p>Dim.: 315 x 180 x 315 mm (w x d x h)</p> <p>for keo® 18470 for standard profile rail 14066</p>
Waste collector tango		<p>Waste collector with knee operation with practical knee operated opening system, body in ABS plastic, white RAL 9016, incl. fixing material for keo®</p> <p>capacity 8 ltrs. Dim.: 220 x 220 x 360 mm (w x d x h) 18358</p> <p>capacity 20 ltrs. Dim.: 350 x 250 x 520 mm (w x d x h) 18359</p>







Item	Description	Ref. no.
Waste container for instruments		<p data-bbox="616 230 1130 315">polypropylene bowl white, can be sterilized up to 134°C. With pivot arm and mounting clamp for keo® trolley.</p> <p data-bbox="616 320 1130 349">Dim.: 300 x 230 x 130 mm (w x d x h)</p> <p data-bbox="616 365 1130 394">with slit lid</p> <p data-bbox="616 394 1130 421">without slit lid</p>
		<p data-bbox="1130 365 1404 394">17771</p> <p data-bbox="1130 394 1404 421">17369</p>





Organisation system / Injection set PicBox®





Organisation system		<p data-bbox="616 685 1130 770">with 2 special steel tilted deposit levels, stainless steel and 10 moveable clips for conventional material packages. (Delivery without stuffing).</p> <p data-bbox="616 801 1130 862">Dim. of the deposit levels: 633 x 150 x 65 mm (w x d x h)</p>	<p data-bbox="1130 801 1404 862">17836</p>
----------------------------	---	--	---







Organisation system with PicBox®		<p data-bbox="616 1055 1130 1167">consisting of the PicBox® canula dispenser with 5 small boxes (First- in/first-out prinzip) and 1 special steel deposit level and 5 clips. (Delivery without stuffing).</p> <p data-bbox="616 1182 1130 1243">Dim. of the canula dispenser: 600 x 135 x 165 mm (w x d x h)</p> <p data-bbox="616 1258 1130 1314">Dim. of the deposit level: 600 x 150 x 65 mm (w x d x h)</p>	<p data-bbox="1130 1258 1404 1314">17991</p>
---	---	---	---





PicBox® injection set		<p data-bbox="616 1415 1130 1579">grey-white plastic housing with transparent PicBox® boxes (First- in/first-out prinzip). Each box has its own dust protection cover. Consisting of 3 injection dispensing boxes and 5 canula dispensing boxes, mounted by screwing between the profiles. (Delivery without stuffing).</p> <p data-bbox="616 1594 1130 1624">Dim.: 600 x 200 x 410 mm (w x d x h)</p>	<p data-bbox="1130 1594 1404 1624">18006</p>
------------------------------	---	---	---

Item	Description	Ref. no.
Dispenser for syringes / Dispenser for canulas / Injection sets		
Dispenser for syringes PicBox® <i>new</i>		with 3 big PicBox® boxes (first-in/first-out principle). Plastic casing, grey-white, boxes with dust-proof lid, transparent. Dim.: 600 x 200 x 245 mm (w x d x h) 17368
Dispenser for canulas PicBox® <i>new</i>		with 5 small PicBox® boxes (first-in/first-out principle). Plastic casing, grey-white, boxes with dust-proof lid, transparent. Dim.: 600 x 135 x 165 mm (w x d x h) 17089
Dispenser 3 for syringes <i>new</i>		with 3 big boxes (filling and removing from above). Grey-white plastic casing with transparent boxes. Dim.: 600 x 200 x 245 mm (w x d x h) 17367
Dispenser 4 for syringes <i>new</i>		with 4 medium-sized boxes (filling and removing from above). Grey-white plastic casing with transparent boxes. Dim.: 600 x 175 x 208 mm (w x d x h) 18130
Dispenser 5 for canulas <i>new</i>		with 5 small boxes (filling and removing from above). Grey-white plastic casing with transparent boxes. Dim.: 600 x 135 x 165 mm (w x d x h) 17606
Injection set 3+5 <i>new</i>		with 3 big and 5 small boxes (filling and removing from above). Grey-white plastic casing with transparent boxes. Dim.: 600 x 200 x 410 mm (w x d x h) 17366
Injection set 4+5 <i>new</i>		with 3 medium-sized and 5 small boxes (filling and removing from above). Grey-white plastic casing with transparent boxes. Dim.: 600 x 200 x 373 mm (w x d x h) 18129

Item	Description	Ref. no.
KOMBI set		<p>for taking blood samples and giving injections. The TAKEFIX swab dispenser and the TIPPFIX swab moistener as well as the additional container are of grey-white, unbreakable plastic.</p> <p>18029</p> <p>Dim.: 120 x 230 x 265 mm (w x d x h)</p>
Universal holder Snap		<p>for dispenser boxes of disposable gloves, tissues or cloths. The spring tension slide holds all types of boxes up to 1 kg in place for single-hand operation.</p> <p>15572</p> <p>Dim.: 100 x 20 x 165 mm (w x d x h)</p>
Holder for dispenser boxes <i>new</i>		<p>made of brushed stainless steel. Suitable for 1 to 3 common dispenser boxes of disposable gloves or tissues. With mounting material.</p> <p>Holder 1-fold (for 1 box) Dim.: 130 x 80 x 218 mm (w x d x h) 18707</p> <p>Holder 3-fold (for 3 boxes) Dim.: 220 x 80 x 370 mm (w x d x h) 18708</p>
Soap and disinfectant dispenser		<p>naturally anodised aluminium. Capacity 1 ltr. with holder for keo®.</p> <p>17850</p> <p>Dim.: 95 x 185 x 290 mm (w x d x h)</p>
Drip tray		<p>separately, removable, to clip on the soap and disinfectant dispenser.</p> <p>16256</p> <p>Dim.: 150 x 260 x 410 mm(w x d x h)</p>
Sensor dispenser <i>new</i>		<p>for standard bottles (1 liter capacity) with liquid soap and disinfectants. Made of natural anodized aluminium with stainless steel holder. Can be mounted to the left or right side. Please specify when ordering.</p> <p>for keo® 17824 for wall mounting with fixing material. 11140</p> <p>Dim.: 95 x 210 x 290 mm (w x d x h)</p>
Drip tray		<p>separately, removable, to clip on the sensor dispenser.</p> <p>16256</p> <p>Dim.: 150 x 260 x 410 mm (w x d x h)</p>

Item	Description	Ref. no.
Schluckfix canula container		black, recycled plastic, disposable container for holding approx. 500 used canulas.
	Dim.: 55 x 100 x 170 mm (w x d x h)	
	Schluckfix-Set with 20 boxes and a keo® mounting Bulk discounts on request.	18004
Schluckfix original carton	with 100 boxes, without mounting	09490
Mounting	for Schluckfix to keo® , separately	18005
Medi-Müll disposal box, 1.5 ltrs. capacity		sun-yellow polypropylene with a HAEBERLE-green lid. It has 3 practical stripping aids for all types of canula, also for vacutainer.
	Ideal for scalpels, pipettes, broken glass, swabs, etc., 152 mm high, lid Ø 143 mm, bottom Ø 108 mm, 1.5 ltrs. capacity.	
	Medi-Müll set with 20 boxes and a keo® mounting Bulk discounts on request..	18050
Medi-Müll carton	with 100 boxes, without mounting	16653
Mounting	for Medi-Müll to keo® , separately	18059
Mount for standard profile rail		for Medi-Müll disposal box. Made of stainless steel, fits for all standard profile rails, on right or left side.
new		16677
	Please order standard profile rail separately. ref. no. 17943	
CUPFIX ampoule opener		grey-white plastic housing, ampoule collector, detachable, diamond file spring-loaded in a stainless steel plate.
	Dim.: 70 x 150 x 200 mm (w x d x h).	18058
	Spare diamond file for CUPFIX	04663
Mounting	for CUPFIX to keo® , separately	18060
Catheter container		stainless steel, subdivided into 3 sections. To be fixed at standard profile rail. Please order standard profile rail, ref.no. 17943, separately.
	Dim.: 160 x 80 x 570 mm (w x d x h)	18065

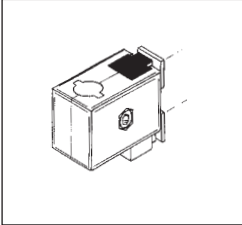
Item	Description	Ref. no.
Standard profile rail	 <p>made of stainless steel with 2 securing points, 480 mm long, for lateral fastening.</p> <p>Please specify the side on which the rail is to be mounted.</p>	17943
Standard rail for carrier profiles <i>new</i>	 <p>made of brushed stainless steel. For mounting between 2 carrier profiles and hooking various accessories.</p> <p>Dim.: 630 x 15 x 25 mm (w x d x h) with lateral holder 100 mm</p>	18328
cardiac massage <i>new</i>	 <p>blue, made of sturdy polyethylene, 2 kg lightweight supports up to 150 kg. Holder made of powder coated, fine textured steel. Suitable for trolleys with minimum 250 mm high rear walls.</p> <p>Dim.: 600 x 420 x 10 mm (w x d x h) for keo®</p>	17370
Holder	 <p>for oxygen bottle, 5/10 litres Ø up to 140 mm</p> <p>mounting</p> <p>top holder with fixing tape, separately</p>	18168 18169
Holder	 <p>for 2 ltrs. oxygen bottle</p> <p>upper supporting ring Ø 102 mm lower supporting ring Ø 84 mm silver aluminium RAL 9006</p>	18007
Infusion bottle holder	 <p>chromium-plated, with four hooks, for single-hand operation, Ø 25 mm</p>	18020

Item	Description	Ref. no.	
Cable and hose holder		arms silver coloured aluminium, attachment clamp included, approx. 950 mm reach.	18433
Cable and hose holder with flex-shaft		with 2 joints made of plastic, arms in silver aluminium and chromium-plated flex-shaft, attachment clamp included.	18943
Attachment clamp		for fastening various accessories to keo®, suitable for holding Ø 10 mm and Ø 16 mm circular tubes.	18018
Multiple socket outlet		4 grounding sockets, light-grey cable, 3 m long with moulded grounding plug, green 2-pin switch, quality housing anodised aluminium, incl. 2 grey plastic fastening angles.	Dim.: 269 x 44 x 44 mm (w x d x h) 21694 Further multiple socket outlets you will find in the separate electrical accessories list.

Electrical accessories

Suitable for the equipment cart systems, we offer you a comprehensive range of electrical accessories in various country-specific versions.

The product range contains:

- Standard multiple socket outlets
- Modular multiple socket outlets
- Central on/off switch
- Isolating transformers
- Equipotential bonding system MultiContact POAG
- Electrical connections according to IEC 320 C13/C14
- Cable management and plug-out protection

On request we send you the separate list with information about the electrical accessories. Please feel free to contact our customer consultants.

All prices are understood exclusive of VAT. As an innovative company we reserve the right to amend prices and designs. As for the rest our General Terms of Business in the valid version apply.

WEEE-Reg.-Nr. DE 20235235



Planning sketch for your keo trolley

Case for 5 height grids

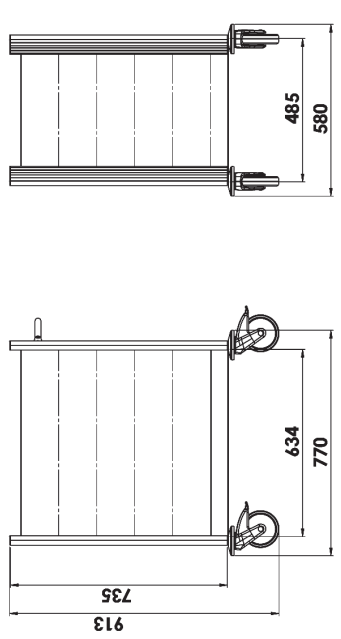

Case for 6 height grids

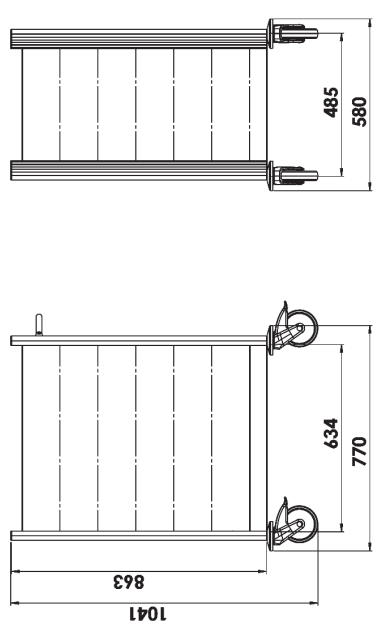

Case for 7 height grids

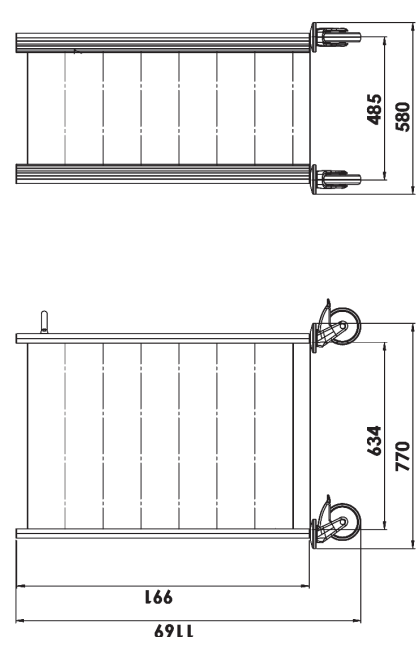

Case for 5 height grids with extended profile supports at rear

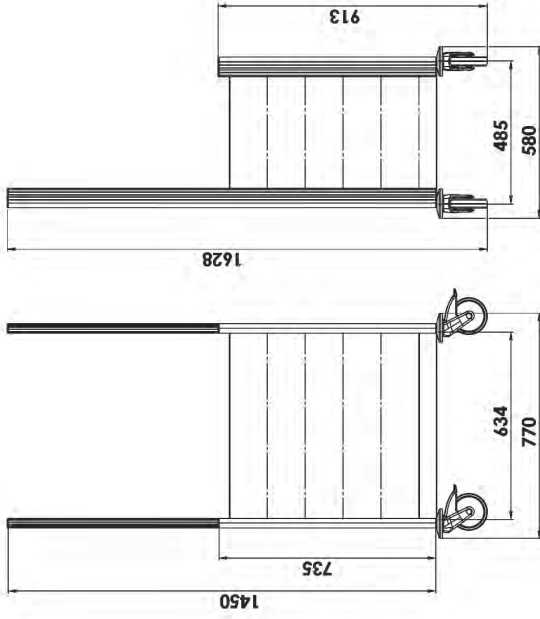

Case for 6 height grids with extended profile supports at rear

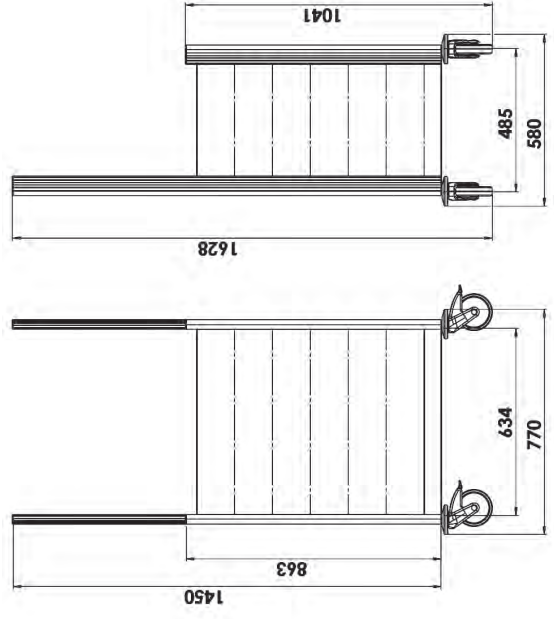

For further models, please feel free to contact our customer consultants!

Work surfaces:



- Metal
- Stainless steel
- Plastic with raised edges
- Insertion plate stainless steel
- with pullout
- right
- left

Colour combinations:

- Case**
- RAL 9002
 - RAL 9002
 - RAL 9002
 - RAL 9002
 - RAL 9002
 - RAL 5022
 - RAL 9006
- Handles / Decorative strips**
- grey
 - blue
 - red violet
 - yellow
 - turquoise
 - RAL 9006 / 5022
 - grey

- RAL 9002 ▲ grey-white
- RAL 9006 ▲ white-aluminium
- RAL 5022 ▲ night-blue

Special colours

RAL RAL /

(Other RAL colour combinations on request)

Notes:

HAEBERLE specializes in particular in providing customized OEM versions for industrial clients. Let us know your specifications and we will provide you a product according to your individual requirements.

Please contact us!



Modern ISO module and functional trolleys with infinite version possibilities – ergonomic and practical for many treatment applications in clinics.

Our versatile product range



Your medical distributor

HAEBERLE GmbH + Co. KG

Breitwiesenstr. 13

DE-70565 Stuttgart

P.O.Box 800524 · DE-70505 Stuttgart

Phone +49 (0) 7 11/7 83 14-0

Fax +49 (0) 7 11/7 83 14-77

Email: info@haeberle-med.de

Internet: www.haerberle-med.de