

Larynx Instrumentarium

Larynx Instruments



Quality you can rely on

30
Years
SPIGGLE & THEIS
1994 - 2024





Über uns

About Us

Herzlich willkommen in unserem Instrumentenkatalog.

Bevor Sie in die Welt unserer ‚MADE IN GERMANY‘ Instrumente eintauchen, möchten wir Ihnen einen kurzen Einblick in unsere Erfolgsgeschichte gewähren.

Was vor 30 Jahren als überschaubares Handelsunternehmen begann, hat sich seitdem zu einem weltweit etablierten Hersteller erstklassiger **HNO-Instrumente und Verbrauchsmaterialien** entwickelt.

Unsere Geschichte ist geprägt von einer tiefen Hingabe zur Hals-, Nasen- und Ohrenchirurgie sowie von kontinuierlicher Weiterentwicklung. **Unsere Leidenschaft** zur HNO spiegelt sich wider in der Partnerschaft mit den medizinischen Fachkräften, die ein integraler Bestandteil unseres Netzwerks und unserer Innovationskraft sind.

Einen weiteren Schlüssel unseres Erfolges stellen **unsere Mitarbeiter** dar, von denen einige bereits seit Jahrzehnten Teil unseres Unternehmens sind. Ihre Fachkompetenz und kontinuierlicher Einsatz haben es uns ermöglicht, zusammen mit Ihnen neue Produkte zu entwickeln und fortlaufend zu verbessern.

2020 ist die **SPIGGLE & THEIS Medizintechnik GmbH** mehrheitlich von der **Thyssen'schen Handelsgesellschaft** übernommen worden, wodurch der weitere Ausbau des Unternehmens, unter Berücksichtigung unserer Innovationskraft und des Qualitätsversprechens, sichergestellt ist. Mit diesem starken Partner an unserer Seite eröffnen sich neue Horizonte, die uns unsere Visionen schneller umsetzen lassen und den Kundenanforderungen noch besser gerecht werden.

Dieser Katalog präsentiert **hochwertige Instrumente**, die auf den Bedürfnissen unserer Kunden und Partner aus der HNO-Medizin basieren. Wir hoffen, dass Sie unser Produktportfolio überzeugt und Sie hier das passende Instrument für Ihre Anforderung finden.

Wir danken Ihnen herzlich für Ihre **Treue** und Ihr **Vertrauen**.

Ihr SPIGGLE & THEIS Team

Welcome to our instrument catalog.

Before you immerse yourself in the world of our ‚MADE IN GERMANY‘ instruments, allow us to offer a brief glimpse into our success story.

What began as a modest trading company three decades ago has since developed into a globally recognized manufacturer of top-tier **ENT instruments and consumables**.

Our history is defined by a profound dedication to ENT surgery, healing practices, and continuous growth. **Our passion** resonates perfectly with the physicians, specialists, and medical professionals who are integral to our network and innovative spirit.

Another vital aspect of our success is **our employees**, some of whom have been with our company for decades. Their expertise and unwavering dedication have empowered us to collaborate with you in developing and consistently enhancing new products.

In 2020, **SPIGGLE & THEIS Medizintechnik GmbH** was primarily acquired by **Thyssen'sche Handelsgesellschaft**, ensuring the company's continued expansion while prioritizing our innovative capacity and commitment to quality. With this robust partnership at our side, new horizons have emerged, accelerating the realization of our visions and enhancing our ability to meet customer demands more efficiently.

This catalog showcases **premium instruments** tailored to the needs of our clients and partners in the field of ENT medicine. We hope you discover the perfect instrument that meets your requirements and allows our commitment to quality to speak for itself.

Thank you very much for your **loyalty** and **trust**.

Your SPIGGLE & THEIS Team



Inhaltsverzeichnis

Table of contents

01	Bruststütze / Chest Support	5
02	Laryngoskope / Laryngoscopes	6 - 11
03	Zahnschutz / Teeth Protection	12
04	Mikroinstrumente / Micro Instruments	13 - 14
05	Saugrohre und Watteträger / Suction Tubes and Cotton Carriers	15
06	Hochfrequenz-Instrumente / High Frequency Instruments.....	16 - 17
07	Endoskopie / Endoscopy.....	18
08	Drehbare Zangen / Rotatable Forceps	19
09	Laryngoskopiezangen / Laryngoscopy Forceps	20 - 23
10	Spezialinstrumente / Special Instruments.....	24
11	Lichtquellen / Lightsources	25
12	Allgemeines / Miscellaneous	26 - 27
13	Sterilisationssysteme / Sterilization Systems	28 - 29
14	Sets	30 - 32
	Index	33 - 34

Attention:

Not every instrument is available in all markets. Availability depends on local regulations. Please contact your SPIGGLE & THEIS representative or distributor, if you have any questions about the availability of our products in your region.

01 Bruststütze

Chest Support



Bruststütze für Erwachsene, Gummiring 9,5 cm, Stützstange 35 cm
Chest support for adults, rubber ring 9.5 cm, rod 35 cm

50-101-00



Stützstange für Bruststütze, Gummiring 9,5 cm
Rod for chest support, rubber ring 9.5 cm

Art.-Nr./No.	Länge / Length (cm)
50-101-10	25 cm, für Kinder / for children
50-101-20	35 cm, für Erwachsene / for adults



Gummiring für Bruststütze, 9,5 cm
Rubber ring for chest support, 9.5 cm

50-101-40



Bruststütze alleine, ohne Stange
Chest support only, without rod

50-101-30



02 Laryngoskope

Laryngoscopes

Geschützte Oberfläche für alle SPIGGLE & THEIS Instrumente macht das Instrument weitgehend resistent gegen mechanische und chemische Einflüsse. Reduziert Licht- und Laser-Reflexe. Einfach bei Ihrer Bestellung "TAN" hinter die jeweilige Artikel-Nummer setzen.

A protective surface for all SPIGGLE & THIS instruments makes the instruments resistant to mechanical and chemical influences whilst reducing light and laser reflections. Order by simply adding "TAN" behind the respective article number.



Videolaryngoskop, Endoskopführung, zur Verwendung mit Endoskop 50-155-00, distal innen 18 x 13 mm, proximal innen 26 x 17 mm, 18,2 cm

Video laryngoscope, endoscope-guide, for use with endoscope 50-155-00, distal interior 18 x 13 mm, proximal interior 26 x 17 mm, 18.2 cm

50-150-00



Winkeloptik HD, zur Verwendung mit Videolaryngoskop 50-150-00, 4,0 mm, 15°, 17,7 cm, autoklavierbar

Angled HD scope, for use with video laryngoscope 50-150-00, 4.0 mm, 15°, 17.7 cm, autoclavable

50-155-00

13,5 / 15,2 / 17 / 17,2 / 18,1 cm



Operations-Laryngoskop / Surgical laryngoscope

Art.-Nr. Art.-No.	Größe Size	Länge Length (cm)	ID (mm)	AD OD (mm)
50-200-01 für Kleinkinder / for small children	1	13,5	11,0	19,5 x 12,0
50-200-02 für Kinder / for children	2	15,2	11,0	20,5 x 13,0
50-200-03 für Jugendliche / for juveniles	3	18,1	12,0	21,0 x 13,0
50-200-04 für Frauen / for women	4	17,2	14,5	26,5 x 15,0
50-200-05 für Männer / for men	5	17,2	16,0	29,0 x 18,5



50-200-01



50-200-02



50-200-03

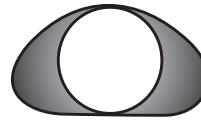

50-200-04

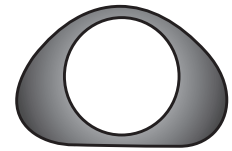

50-200-05

13,5 / 15,2 / 17,2 / 18,2 cm



Operations-Laryngoskop, spreizbar / Surgical laryngoscope, spreadable

Art.-Nr. Art.-No.	Größe Size	Länge Length (cm)	ID (mm)	AD OD (mm)
50-202-01 für Kleinkinder / for small children	1	13,5	11,0	20,0 x 12,0
50-202-02 für Kinder / for children	2	15,2	11,0	21,0 x 13,0
50-202-03 für Jugendliche / for juveniles	3	18,2	12,0	21,0 x 13,0
50-202-04 für Frauen / for women	4	17,2	14,5	27,0 x 15,0
50-202-05 für Männer / for men	5	17,2	16,0	29,0 x 19,0



50-202-01



50-202-02



50-202-03



50-202-04



50-202-05



02 Laryngoskope

Laryngoscopes

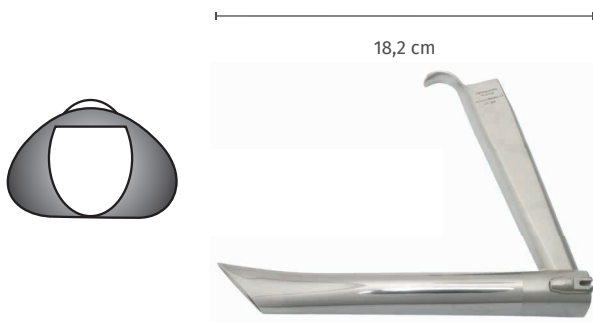

Operations-Laryngoskop, Größe 6, für vordere Kommissur, ID 18 x 13 mm, AD 26 x 17 mm, 18,2 cm

Surgical laryngoscope, size 6, for anterior commissure, ID 18 x 13 mm, OD 26 x 17 mm, 18.2 cm

50-200-06

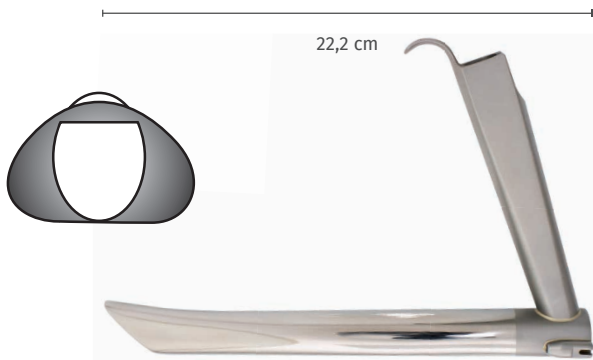

Operations-Laryngoskop, Größe 7, für lange Hälsa, 22,2 cm, ID 18 x 13 mm, AD 26 x 17,5 mm, 22,2 cm

Surgical laryngoscope, size 7, for long necks, ID 18 x 13 mm, OD 26 x 17.5 mm, 22.2 cm

50-200-07

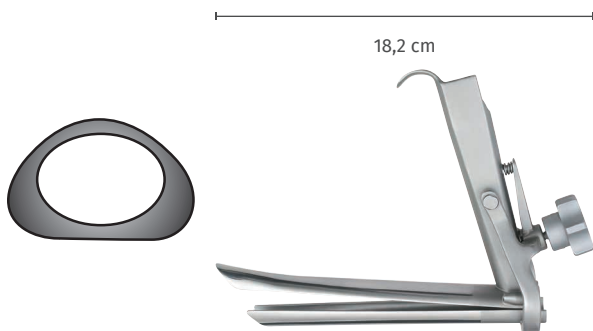

Operations-Laryngoskop, Größe 6, spreizbar, für vordere Kommissur, ID 18 x 13 mm, AD 26 x 17 mm, 18,2 cm,

Surgical laryngoscope, size 6, spreadable, for anterior commissure, ID 18 x 13 mm, OD 26 x 17 mm, 18.2 cm

50-202-06

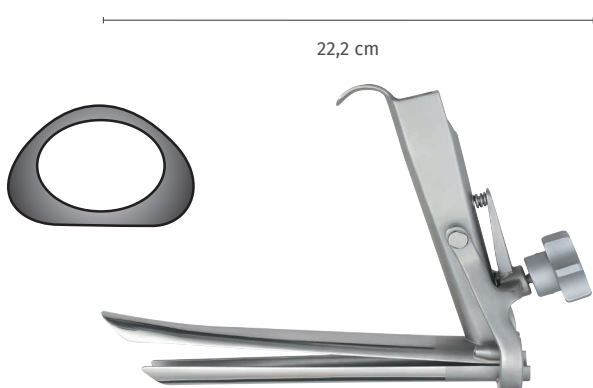

Operations-Laryngoskop, Größe 7, spreizbar, für lange Hälsa, ID 18 x 13 mm, AD 26 x 17 mm, 22,2 cm

Surgical laryngoscope, size 7, spreadable, for long necks, ID 18 x 13 mm, OD 26 x 17 mm, 22.2 cm

50-202-07

02 Laryngoskope

Laryngoscopes



Fiberglas-Lichtträger für starre und spreizbare Laryngoskope, 14 cm
Fiberglass lightcarrier for rigid and spreadable laryngoscopes, 14 cm

Art.-Nr./No.	Für Größen / For Sizes
50-205-12	1 / 2
50-205-36	3 / 4 / 5 / 6
50-205-70	7



Rauchabsaugrohr für starre und spreizbare Laryngoskope
Größe 3 bis 7, 14 cm Länge
Smoke evacuation tube for rigid and spreadable laryngoscopes
size 3 to 7, 14 cm length

50-207-17



Inject-Timer-Kanüle für starre und spreizbare Laryngoskope
Größe 1 bis 7, 11 cm Länge
Inject timer cannula for rigid and spreadable laryngoscopes
size 1 to 7, 11 cm length

50-209-17

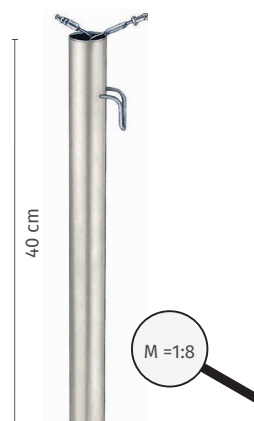

Köcher für Saugrohre, 40 cm, Ø 40 mm,
zum Einhängen an OP-Schiene
Quiver for suction tubes, 40 cm, Ø 40 mm,
for hook on op-table bar

50-330-40



02 Laryngoskope

Laryngoscopes



Laser-Laryngoskop / Laser laryngoscope

Art.-Nr. Art.-No.	Größe Size	Länge Length (cm)	ID (mm)	AD OD (mm)
50-215-01	1 für Kleinkinder / for small children	13,5	11,0	19,5 x 12,0
50-215-02	2 für Kinder / for children	15,2	11,0	20,5 x 13,0
50-215-03	3 für Jugendliche / for juveniles	18,1	12,0	21,0 x 13,0
50-215-04	4 für Frauen / for women	17,2	14,5	26,5 x 15,0
50-215-05	5 für Männer / for men	17,2	16,0	29,0 x 18,5

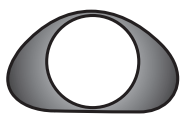

50-215-01



50-215-02

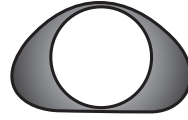

50-215-03

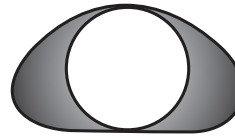

50-215-04

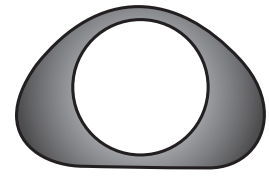

50-215-05



Laser-Laryngoskop, Größe 6, für vordere Kommissur, ID 18 x 13 mm, AD 26 x 17 mm, 18,2 cm

Laser laryngoscope, size 6, for anterior commissure,
ID 18 x 13 mm, OD 26 x 17 mm, 18.2 cm

50-215-06



Laser-Laryngoskop, Größe 7, für lange Hälse, ID 18 x 13 mm, AD 26 x 17,5 mm, 22,2 cm

Laser laryngoscope, size 7, for long necks,
ID 18 x 13 mm, OD 26 x 17.5 mm, 22.2 cm

50-215-07

02 Laryngoskope

Laryngoscopes

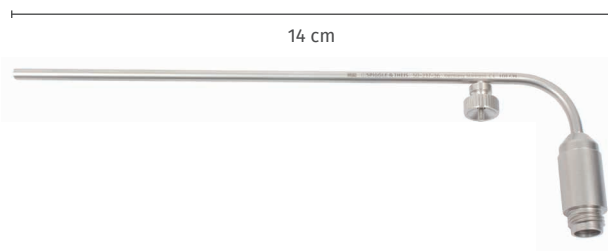

Fiberglas-Lichtträger für Laserlaryngoskope, 14 cm
Fiberglass lightcarrier for laser laryngoscopes, 14 cm

Art.-Nr./No.	Für Größen / For Sizes
50-217-12	1 / 2
50-217-36	3 / 4 / 5 / 6
50-217-70	7



Rauchabsaugrohr für Laserlaryngoskope Größen 3 bis 7, 17 cm
Smoke evacuation tube for laser laryngoscopes size 3 to 7, 17 cm

Art.-Nr./No.	Für Größen / For Sizes
50-218-12	1 / 2
50-218-17	3 / 4 / 5 / 6 / 7

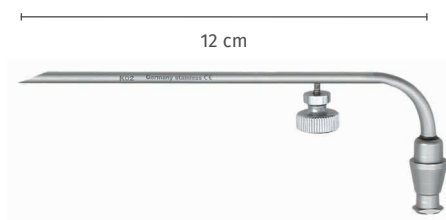

Inject-Timer-Kanüle für Laserlaryngoskope Größen 1 bis 7, 12 cm
Inject timer cannula for laser laryngoscopes size 1 to 7, 12 cm

50-219-17



**Holinger Laryngoskop, Handgriff abnehmbar,
 Lichtträger innen mattiert**
**Holinger laryngoscope, handle removable,
 light carrier satin finished inside**

Art.-Nr./No.	Größen / Sizes
50-229-01	1 (12,0 cm)
50-229-02	2 (17,1 cm)
50-229-03	3 (18,0 cm)



Jackson Laryngoskop, Handgriff abnehmbar, Lichtträger innen mattiert
Jackson laryngoscope, handle removable, light carrier satin finished inside

Art.-Nr./No.	Größen / Sizes
50-232-01	1 (12,0 cm)
50-232-02	2 (17,1 cm)
50-232-03	3 (18,0 cm)



Laryngoskop-Handgriff, abnehmbar, einzeln
Laryngoscope handle, removable, separate

50-235-00



03 Zahnschutz

Teeth Protectors



Endoragard Zahnschutz, doppelseitig, Kunststoff, unsteril
Endoragard teeth protector, double side, plastic, non-sterile

50-240-00



Zahnschutz aus Metall, gelocht
Teeth protector, metal, with holes

Art.-Nr./No.	Größen / Sizes
50-245-00	0, sehr klein / very small
50-245-01	1, klein / small
50-245-02	2, mittel / medium
50-245-03	3, groß / large



Medasil Zahnschutz, Silikon, steril, lasergeeignet, 20 Stück
Medasil teeth protector, silicone, sterile, laser resistant, 20 pieces

50-250-00

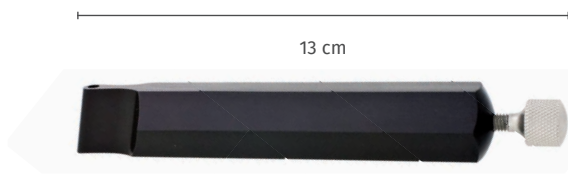

Heermann Handgriff, groß, schwarz, 13 cm
Heermann handle, large, black, 13 cm

10-722-13

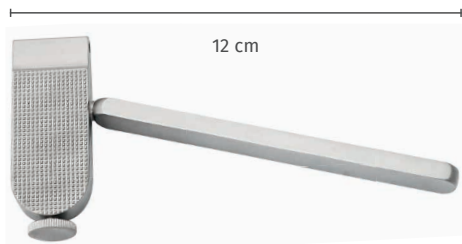

Kleinsasser Handgriff, gewinkelt, 12 cm
Kleinsasser handle, angled, 12 cm

50-300-00

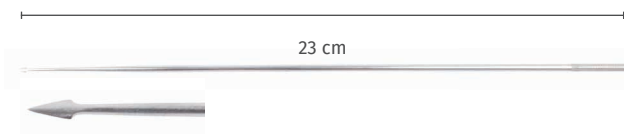

Messer, gerade, lanzettförmig, 23 cm
Knife, straight, lanceolate, 23 cm

50-301-23

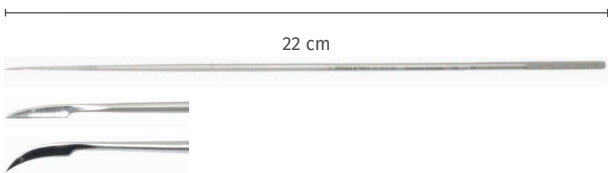

Sichelmesser, AL 22 cm / Sickle knife, WL 22 cm

Art.-Nr./No.	Winkel / Angle
50-310-23	gerade Schneide / straight edge
50-311-23	gebogene Schneide / curved edge

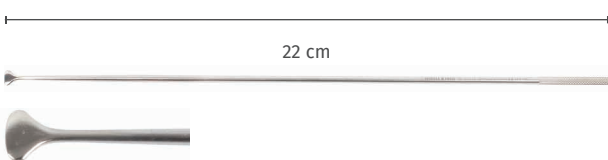

Messer, oval, AL 22 cm / Knife, oval, WL 22 cm

50-312-23



Messer, rund, 2,5 mm, 45° gewinkelt, AL 22 cm
Knife, round, 2.5 mm, 45° angled, WL 22 cm

50-313-23

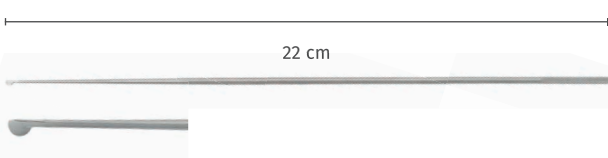

Messer, oval, seitlich, AL 22 cm / Knife, oval, vertical, WL 22 cm

50-314-23



04 Mikroinstrumente

Micro Instruments

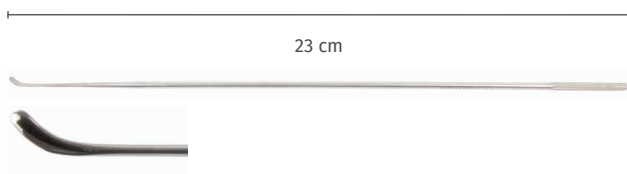

Messer, golfstockförmig, AL 23 cm
 Knife, golf club shaped, WL 23 cm

50-315-23

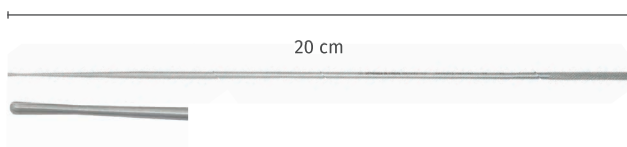

Sonde, stumpf, gerade, AL 20 cm / Probe, blunt, straight, WL 20 cm

50-232-23

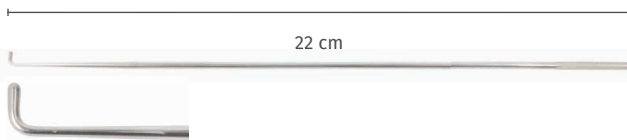

Häkchen, stumpf, 90°, AL 22 cm / Hook, blunt, 90°, WL 22 cm

50-317-23

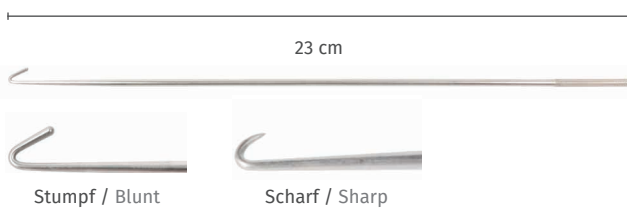

Häkchen, retrograd, AL 23 cm / Hook, backwards, WL 23 cm

Art.-Nr./No.	Beschreibung / Description
50-316-23	stumpf / blunt
50-318-23	scharf / sharp

Stumpf / Blunt

Scharf / Sharp

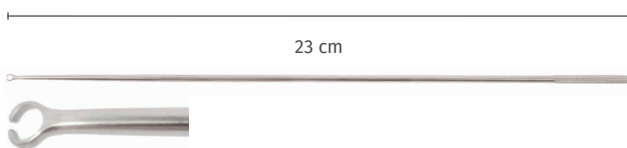

Knotenführer, gerade, AL 23 cm / Knot tier, straight, WL 23 cm

50-319-23

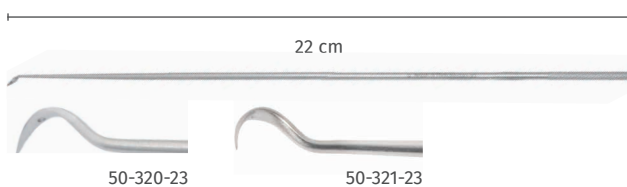

Umstechungsnadel, AL 22 cm / Suture needle, WL 22 cm

Art.-Nr./No.	Beschreibung / Description
50-320-23	rechts gebogen / right curved
50-321-23	links gebogen / left curved

50-320-23

50-321-23

05 Saugrohre und Watteträger

Suction Tubes and Cotton Carriers

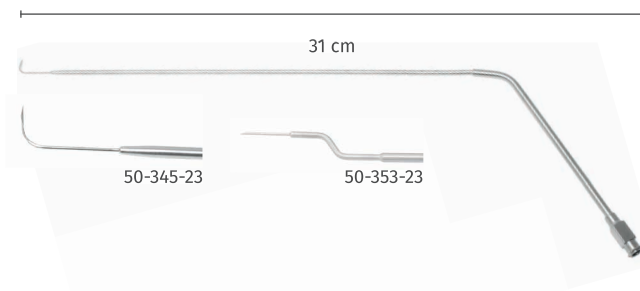

Injektionsnadel, 31 cm, AL 24 cm
Injection needle, 31 cm, WL 24 cm

Art.-Nr./No.	Beschreibung / Description
50-345-23	gebogen / curved
50-353-23	bajonett / bayonet

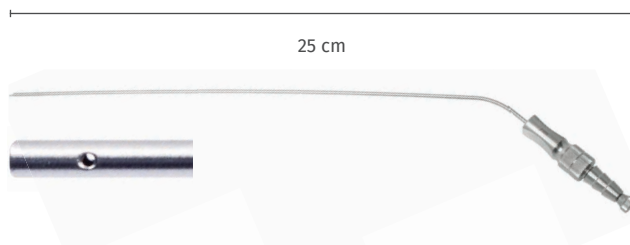

Saugrohr mit Unterbrecher, kniegebogen, seitlich distale Öffnung, 25 cm
Suction tube with interruptor, angled, distal side opening, 25 cm

Art.-Nr./No.	ID / ID (mm)
50-347-20	2,0
50-347-25	2,5
50-347-30	3,0

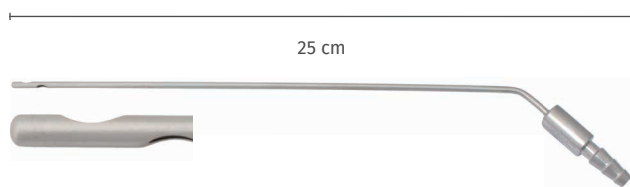

Saugrohr mit Unterbrecher, Spitze geschlossen, zwei seitliche Öffnungen 3,0 mm, 25 cm
Suction tube with interruptor, tip closed, two side openings 3.0 mm, 25 cm

50-349-30

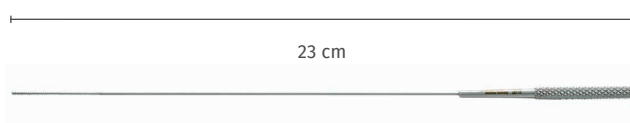

Watteträger, gerieft, 2 mm, 23 cm
Cotton carrier, serrated, 2 mm, 23 cm

50-351-23



06 Hochfrequenz-Instrumente

High Frequency Instruments

Monopolare Koagulationszange, drehbar, Rauchabsaugung, Schaft 3,0 mm, 23,5 cm
Monopolar coagulation forceps, rotatable, smoke evacuation, shaft 3.0 mm, 23.5 cm



Art.-Nr./No.	Beschreibung / Description
50-411-23	gerade, gerieft / straight, serrated
50-412-23	gebogen, gerieft / curved, serrated
50-414-23	runde Löffel / round cups

Vorteile:

- Monopolare Koagulation
- 360° drehbar
- Rauchabsaugung beim Lasern
- Reflexionsarme schwarze Oberfläche

Advantages:

- Monopolar coagulation
- 360° rotatable
- Laser smoke evacuation
- Non-reflecting black finish

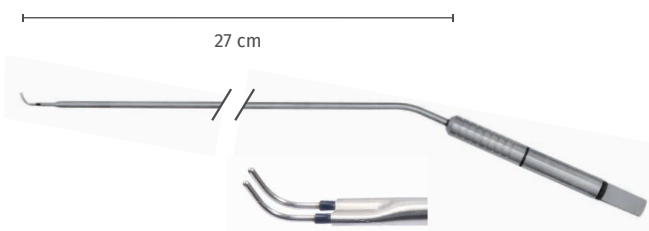

Bipolare Koagulationselektrode, innen isoliert, 27 cm Arbeitslänge
Bipolar coagulation electrode, inside isolated, 27 cm working length

50-365-27

06 Monopolares Zubehör, Monopolare Anschlusskabel, autoklavierbar*

Monopolar Accessory, monopolar connecting cable, autoclavable*



für Instrumente, 5 m, passend für
for instruments, 5 m compatible to
Martin/Sutter/Berchthold/Aesculap/Integra/SPIGGLE & THEIS

80-414-50



für Instrumente, 4 mm, 5 m passend für
for instruments, 4 mm, 5 m, compatible to
Erbe ICC/ACC, Wolf/Storz

80-415-50

06 Bipolares Zubehör, Bipolare Anschlusskabel, autoklavierbar*

Bipolar Accessory, bipolar connecting cable, autoclavable*



passend für / compatible to
Erbe/EMC/Dolly Stecker

Art.-Nr./No.	Länge / Length (m)
80-316-50	5,0

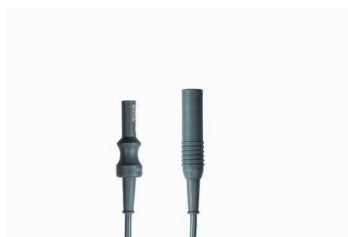

passend für / compatible to
Sutter/Martin/Berchthold/Aesculap/Integra/SPIGGLE & THEIS

Art.-Nr./No.	Länge / Length (m)
80-317-30	3,0
80-317-50	5,0



passend für / compatible to Erbe/Storz/Wolf

Art.-Nr./No.	Länge / Length (m)
80-318-30	3,0
80-318-50	5,0



passend für / compatible to Valleylab/Lamidey/EMC/Bowa/Olympus

Art.-Nr./No.	Länge / Length (m)
80-319-30	3,0
80-319-50	5,0

* Abbildungen der Kabel sind ähnlich / images similar to product



07 Endoskopie

Endoscopy

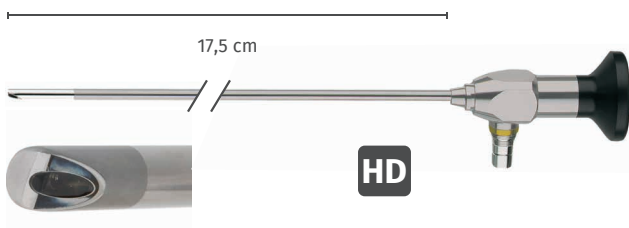

Laryngoskop, HD, autoklavierbar, 17,5 cm

Laryngoscope, HD, autoclavable, 17.5 cm

Art.-Nr. Art.-No.	AD OD (mm)	Winkel Angle	
40-100-70	4	70°	<input type="radio"/>
40-100-90	4	90°	<input type="radio"/>



Laryngoskop, HD, autoklavierbar, Handgriff, 19 cm

Laryngoscope, HD, autoclavable, handle, 19 cm

Art.-Nr. Art.-No.	AD OD (mm)	Winkel Angle	
40-103-70	10	70°	<input type="radio"/>
40-103-90	10	90°	<input type="radio"/>



Laryngoskop, HD, autoklavierbar, Handgriff, 19,8 cm

Laryngoscope, HD, autoclavable, handle, 19.8 cm

Art.-Nr. Art.-No.	AD OD (mm)	Winkel Angle	
40-107-70	8	70°	<input type="radio"/>



Laryngoskop, HD, autoklavierbar, 30,2 cm

Laryngoscope, HD, autoclavable, 30.2 cm

Art.-Nr. Art.-No.	Größe Size (mm)	Winkel Angle	
40-110-00	4,0	0°	<input type="radio"/>
40-110-30	4,0	30°	<input type="radio"/>
40-110-70	4,0	70°	<input type="radio"/>
40-112-00	4,0	0°	<input type="radio"/>
40-112-30	2,7	30°	<input type="radio"/>
40-112-70	2,7	70°	<input type="radio"/>

08 Drehbare Zangen

Rotatable Forceps

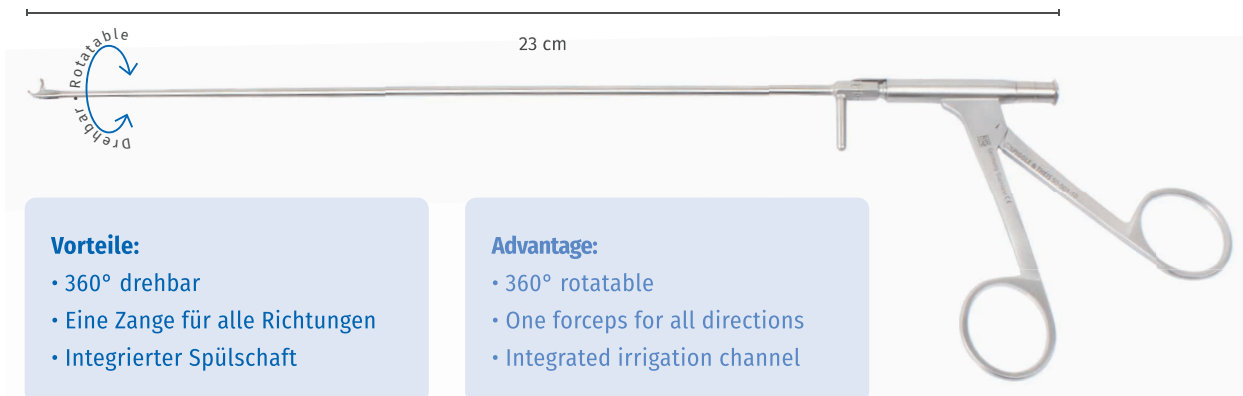

Vorteile:

- 360° drehbar
- Eine Zange für alle Richtungen
- Integrierter Spülkanal

Advantage:

- 360° rotatable
- One forceps for all directions
- Integrated irrigation channel



Mikrolaryngoskopiezange, drehbar, runde Löffel, aufw. gebogen, Spülkanal, 2,0 mm
Microlaryngoscopy forceps, rotatable, round cups, curved upwards, irrigation channel, 2.0 mm

Art.-Nr./No.	Länge / Length (cm)
50-501-10	23,0
50-501-10-L*	23,5



Mikrolaryngoskopiezange, drehbar, Alligator, gebogen, Spülkanal
Microlaryngoscopy forceps, rotatable, alligator, curved upwards, irrigation channel

Art.-Nr./No.	Länge / Length (cm)
50-502-10	23,5
50-502-10-L*	23,5



Mikrolaryngoskopiezange, drehbar, dreieckiges Maul, gebogen, Spülkanal, 23,5 cm
Microlaryngoscopy forceps, rotatable, triangular tip, curved upwards, irrigation channel, 23.5 cm

Art.-Nr./No.	Länge / Length (cm)
50-503-10	23,0
50-503-10-L*	23,5



Mikrolaryngoskopieschere, drehbar, aufgebogen, Spülkanal, 23,5 cm
Microlaryngoscopy scissors, rotatable, curved upwards, irrigation channel, 23.5 cm

Art.-Nr./No.	Länge / Length (cm)
50-504-10	23,5
50-504-10-L*	23,5

*lasergeeignet / suitable for lasers



09 Laryngoskopie zangen

Laryngoscopy Forceps

Vorteile / Advantages:

- Integrierter Spülschaft für optimierte Reinigung / Integrated irrigation channel for optimal cleaning
- Konischer Schaft für hohe Stabilität und optimale Sicht / Conical shaft for high stability and optimal view

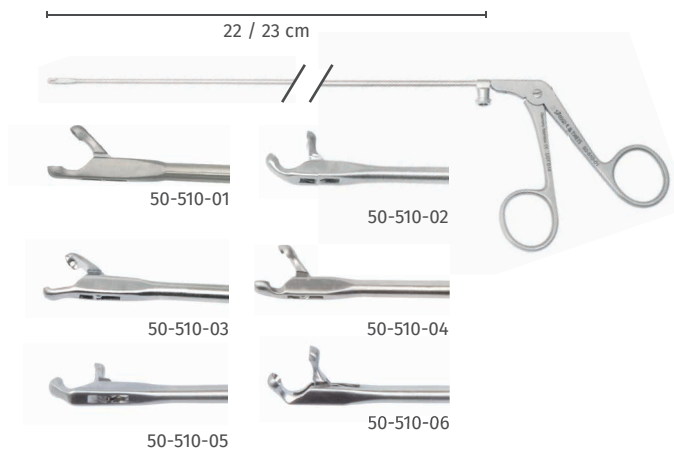

Mikrolaryngoskopiezange mit Spülkanal, runde Löffel, 2,0 mm, konischer Schaft (2,0 - 3,0 mm) Micro laryngeal forceps with irrigation channel, round cups, 2.0 mm, conical shaft (2.0 - 3.0 mm)

Art.-Nr./No.	Winkel / Angle
50-510-01	22 cm, gerade / 22 cm, straight
50-510-01-L*	22 cm, gerade / 22 cm, straight
50-510-02	22 cm, aufgebogen / 22 cm, upcurved
50-510-03	22 cm, rechts gebogen / 22 cm, right curved
50-510-04	22 cm, links gebogen / 22 cm, left curved
50-510-05	22 cm, rechts aufgebogen / 22 cm, right upcurved
50-510-06	23 cm, (2,5 - 3,0 mm) links aufgebogen 23 cm, (2,5 - 3,0 mm) left upcurved

*lasergeeignet / suitable for lasers

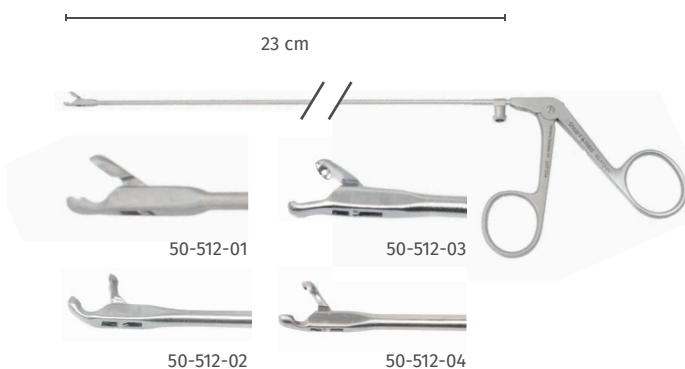

Mikrolaryngoskopiezange mit Spülkanal, konischer Schaft (2,5 - 3,0 mm), runde Löffel, 4,0 mm, 23 cm Micro laryngeal forceps with irrigation channel, conical shaft (2.5 - 3.0 mm), round cups, 4.0 mm, 23 cm

Art.-Nr./No.	Winkel / Angle
50-512-01	gerade / straight
50-512-02	aufgebogen / upcurved
50-512-03	rechts gebogen / right curved
50-512-04	links gebogen / left curved

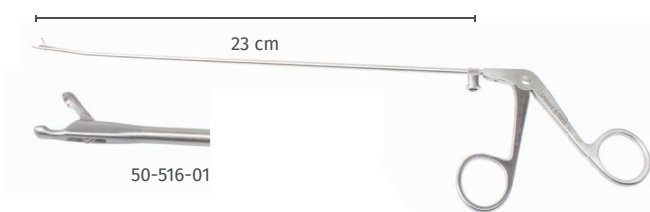

Mikrolaryngoskopiezange Löffelmaul mit Spülkanal, 2 mm konischer Schaft, distales Ende 10° aufgebogen, 23 cm Micro laryngeal forceps with round cups, 2 mm conical shaft, distal 10° curved upwards, irrigation channel, 23 cm

Art.-Nr./No.	Winkel / Angle
50-516-01	gerade / straight
50-516-02	45° aufgebogen / 45° upcurved
50-516-03	rechts gebogen / right curved
50-516-04	links gebogen / left curved

09 Laryngoskopiezangen

Laryngoscopy Forceps

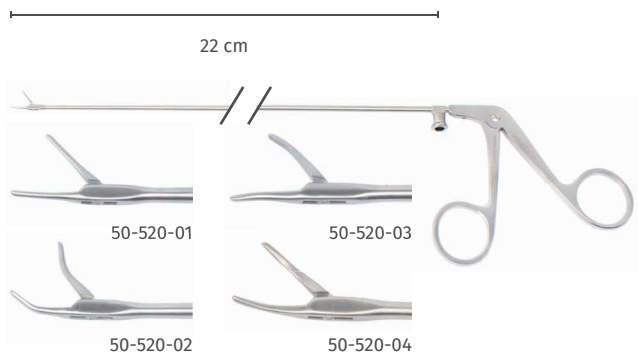

Mikrolaryngoskopiezange mit Spülkanal, Hechtmaul, gerieft, konischer Schaft (2,0 - 3,0 mm), 22 cm

Micro laryngeal forceps with irrigation channel, alligator jaw, serrated, conical shaft (2.0 - 3.0 mm), 22 cm

Art.-Nr./No.	Winkel / Angle
50-520-01	gerade / straight
50-520-02	aufgebogen / upcurved
50-520-03	rechts gebogen / right curved
50-520-04	links gebogen / left curved

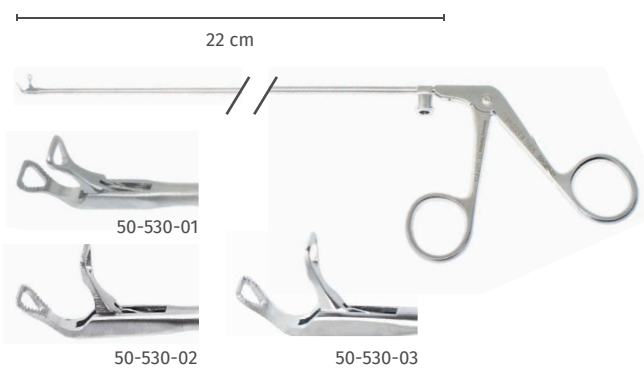

Mikrolaryngoskopiezange mit Spülkanal, Herzform, aufgebogen, konischer Schaft (2,0 - 3,0 mm), 22 cm

Micro laryngeal forceps with irrigation channel, heart shaped jaws, upcurved, conical shaft (2.0 - 3.0 mm), 22 cm

Art.-Nr./No.	Winkel / Angle
50-530-01	gerade / straight
50-530-02	45° rechts / 45° right
50-530-03	45° links / 45° left

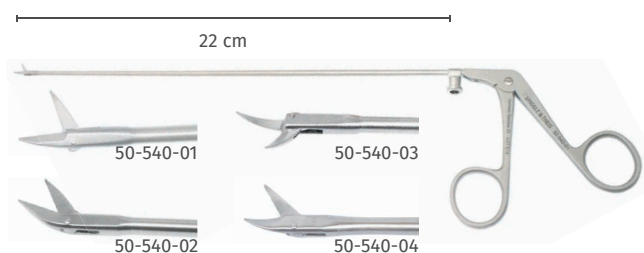

Mikrolaryngoskopieschere mit Spülkanal, konischer Schaft (2,0 - 3,0 mm), 22 cm

Micro laryngeal scissors with irrigation channel, conical shaft (2.0 - 3.0 mm), 22 cm

Art.-Nr./No.	Winkel / Angle
50-540-01	gerade / straight
50-540-01-L*	gerade / straight
50-540-02	aufgebogen / upcurved
50-540-03	rechts gebogen / right curved
50-540-03-L*	rechts gebogen / right curved
50-540-04	links gebogen / left curved
50-540-04-L*	links gebogen / left curved

*lasergeeignet / suitable for lasers



09 Laryngoskopiezangen

Laryngoscopy Forceps

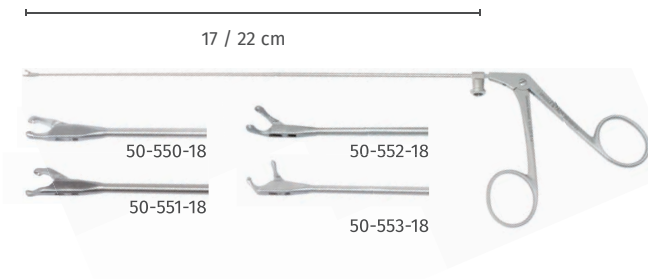

**Mikrolaryngoskopiezange mit Spülkanal,
extra fein, runde Löffel, 1,0 mm, konischer Schaft (1,0 - 2,0 mm)**
**Micro laryngeal forceps with irrigation channel,
very fine, round cups, 1.0 mm, conical shaft (1.0 - 2.0 mm)**

Art.-Nr. Art.-No.	Länge Length (cm)	Winkel Angle
50-550-18	17	gerade / straight
50-550-23	22	gerade / straight
50-551-18	17	rechts gebogen / right curved
50-551-23	22	rechts gebogen / right curved
50-552-18	17	links gebogen / left curved
50-552-23	22	links gebogen / left curved
50-553-18	17	aufgebogen / upcurved
50-553-23	22	aufgebogen / upcurved

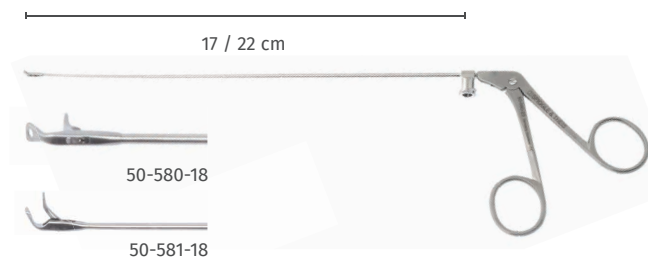

**Mikrolaryngoskopiezange mit Spülkanal,
extra fein, Herzform, 1,0 mm, konischer Schaft (1,0 - 2,0 mm)**
**Micro laryngeal forceps with irrigation channel,
very fine, heartshaped jaw, 1.0 mm, conical shaft (1.0 - 2.0 mm)**

Art.-Nr. Art.-No.	Länge Length (cm)	Winkel Angle
50-580-18	17	rechts gebogen / right curved
50-580-23	22	rechts gebogen / right curved
50-581-18	17	links gebogen / left curved
50-581-23	22	links gebogen / left curved

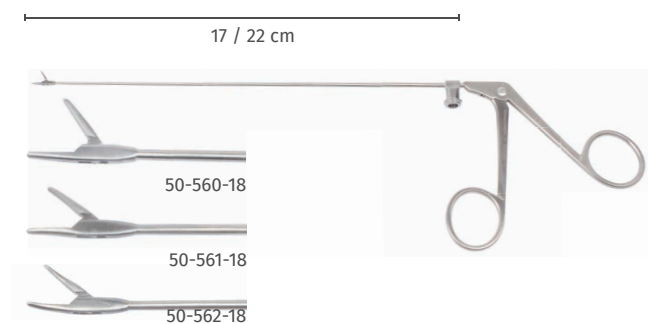

**Mikrolaryngoskopiezange mit Spülkanal,
extra fein, Hechtmaul, 1,0 mm, konischer Schaft (1,0 - 2,0 mm)**
**Micro laryngeal forceps with irrigation channel,
very fine, alligator jaws, 1.0 mm, conical shaft (1.0 - 2.0 mm)**

Art.-Nr. Art.-No.	Länge Length (cm)	Winkel Angle
50-560-18	17	gerade / straight
50-560-23	22	gerade / straight
50-561-18	17	rechts gebogen / right curved
50-561-23	22	rechts gebogen / right curved
50-562-18	17	links gebogen / left curved
50-562-23	22	links gebogen / left curved

09 Laryngoskopiezangen

Laryngoscopy Forceps

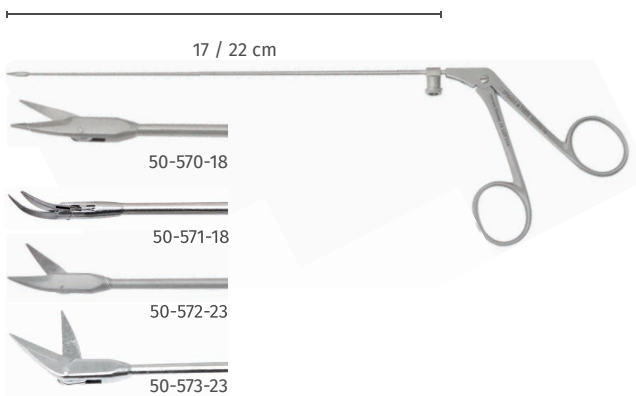

**Mikrolaryngoskopieschere mit Spülkanal,
extra fein, 1,0 mm, konischer Schaft (1,0 - 2,0 mm)**
**Micro laryngeal scissors with irrigation channel,
very fine, 1.0 mm, conical shaft (1.0 - 2.0 mm)**

Art.-Nr. Art.-No.	Länge Length (cm)	Winkel Angle
50-570-18	17	gerade / straight
50-570-23	22	gerade / straight
50-571-18	17	rechts gebogen / right curved
50-571-23	22	rechts gebogen / right curved
50-572-18	17	links gebogen / left curved
50-572-23	22	links gebogen / left curved
50-573-18	18	aufgebogen / upcurved
50-573-23	22	aufgebogen / upcurved



**Mikrolaryngoskopiescherchen mit konischem Schaftrohr,
Schaft distal 10° aufgebogen, Spülung, NL 22 cm**
**Micro laryngeal scissors with conical shaft, distal 10° curved
upwards, 22 cm, irrigation channel**

Art.-Nr. Art.-No.	Winkel Angle
50-590-23	gerade / straight
50-591-23	rechts gebogen / right curved
50-592-23	links gebogen / left curved
50-593-23	45° aufgebogen / 45° upcurved



10 Spezialinstrumente

Special Instruments

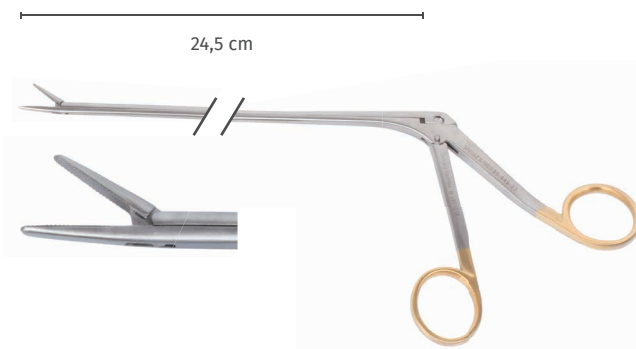

Laryngoskopie-Nadelhalter
Ring 20° aufgebogen, Hartmetall, 24,5 cm
 Laryngeal needle-holder
 ring curved 20° upwards, tungsten carbide, 24.5 cm
50-649-23

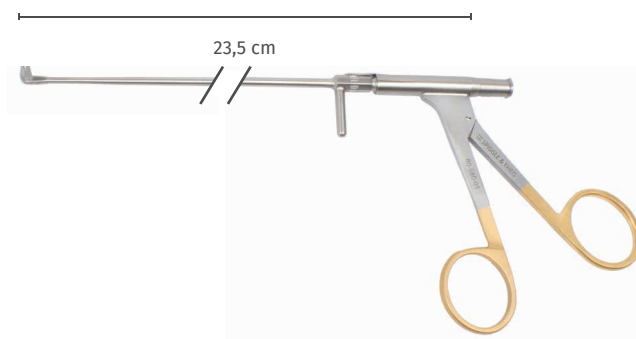

Mikrolaryngoskopieschere, drehbar, 80° aufgebogen, Spülkanal, 23,5 cm
 Microlaryngoscopy scissors, rotatable, 80° curved upwards, irrigation channel, 23.5 cm

Art.-Nr./No.	Beschreibung / Description
50-580-01	festes Schneideblatt rechts / fixed blade right
50-580-01-L*	festes Schneideblatt rechts / fixed blade right
50-580-02	festes Schneideblatt links / fixed blade left
50-580-02-L*	festes Schneideblatt links / fixed blade left

*lasergeeignet / suitable for lasers

Vorteile / Advantages:

- Integrierter Spülkanal für optimierte Reinigung / Integrated irrigation channel for optimal cleaning
- Konischer Schaft für hohe Stabilität und optimale Sicht / Conical shaft for high stability and optimal view

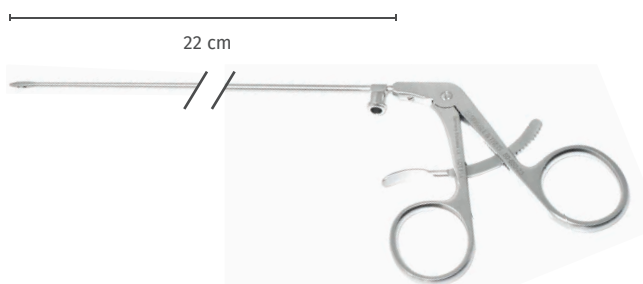

Laryngoskopie-Nadelhalter mit Spülkanal, mit Sperre, konischer Schaft (2,0 - 3,0 mm), 22 cm
 Laryngeal needle-holder with irrigation channel, with ratchet, conical shaft (2.0 - 3.0 mm), 22 cm
50-650-23

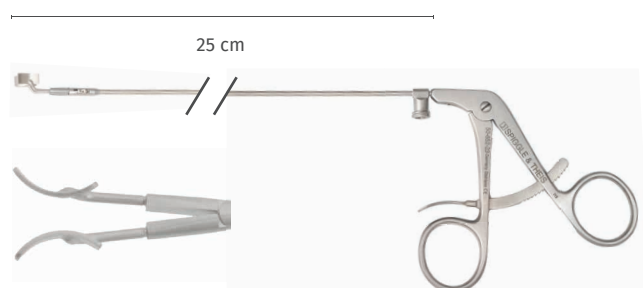

Stimmband-Spreizer mit Spülkanal, zylindrischer Schaft, 2,0 mm, 25 cm
 Vocal cord spreader with irrigation channel, cylindrical shaft, 2.0 mm, 25 cm
50-652-23

LED-Leuchtgriffe / LED light handles

Art-Nr./No.



70-211-00 LED-Hochleistungs-Leuchtgriff, 230 V, bestehend aus:
(70-211-10, 70-211-20, 70-211-30, 70-211-40)
LED high performance light-handle, 230 V, consisting of:
(70-211-10, 70-211-20, 70-211-30, 70-211-40)



70-211-01 LED-Hochleistungs-Leuchtgriff, 120 V, bestehend aus:
(70-211-10, 70-211-20, 70-211-30, 70-211-50)
LED high performance light-handle, 120 V, consisting of:
(70-211-10, 70-211-20, 70-211-30, 70-211-50)

70-211-10 LED-Handgriff, schwarz, mit Helligkeitsdimmer, Ausschaltautomatik, 3 W, 5500 °K, 17500 Lux, zur Verwendung mit Li-Ionen-Akku 3,7 V und Endoskop-Adapter, 50 Std. Brenndauer
LED light handle, black, with brightness dimmer, automatic switch-off, 3 W, 5500 °K, 17500 lux, to use with Li-ion chargeable battery 3.7 V and endoscope adapter, 50 hours run-time



70-211-20 Li-Ionen-Akku, 3,7 V, für LED-Handgriff
Li-ion rechargeable battery, 3.7 V, for LED light-handle

70-211-30 Endoskopie-Adapter für LED-Handgriff, passend für Standardgewinde an Endoskopen (AcMI-Gewinde)
Endoscope adapter for LED light-handle, fits standard endoscope threads (AcMi-thread)



70-211-40 Ladegerät für bis zu 2 LED-Handgriffe, 3,5 V, 230 V, Standgerät, Wandhalterung
Charging base for up to 2 LED light-handles, 3.5 V, 230 V, table model, with wall holder

70-211-50 Ladegerät für bis zu 2 LED-Handgriffe, 3,5 V, 120 V, Standgerät, Wandhalterung
Charging base for up to 2 LED light-handles, 3.5 V, 120 V, table model, with wall holder



Metallschale / Metal bowl

Art.-Nr. Art.-No.	Durchmesser Diameter (mm)	Höhe Height (mm)	Fassungs- vermögen Capacity (ml)
80-501-01 B1	Ø 40	H=19	20
80-501-02 B2	Ø 60	H=39	60
80-501-03 B3	Ø 85	H=40	160
80-501-04 B4	Ø 110	H=55	400



Medizinbecher, Edelstahl, graduiert

Medicine cup, stainless steel, graduated

Art.-Nr. Art.-No.	Durchmesser Diameter (mm)	Höhe Height (mm)	Fassungs- vermögen Capacity (ml)
80-503-03	Ø 50	H=25	30
80-504-05	Ø 53	H=45	50



Lösungsschale, Edelstahl / Solution bowl, stainless steel

Art.-Nr. Art.-No.	Durchmesser Diameter (mm)	Höhe Height (mm)	Fassungs- vermögen Capacity (ml)
80-506-30 B1	Ø 95	H=60	300
80-507-40 B2	Ø 120	H=70	500
80-509-75 B3	Ø 150	H=75	750



Tablettenschale, Edelstahl, Ø 65 mm, H=20 mm

Tablet dish, stainless steel, Ø 65 mm, H=20 mm

80-512-00



Petrischale, Klarglas, mit Deckel / Petri dish, clear glass, with lid

Art.-Nr./No.	AD / OD (mm)	Höhe / Height (mm)
80-515-06	60	15
80-515-08	80	15
80-515-10	150	20



Medikamenten-Schälchen, Glas, schwarz, mit Deckel, 4 x 4 cm

Medication dish, glass, black, with lid, 4 x 4 cm

80-517-00

Medikamenten-Schälchen, Dappenglas, farbig, Ø 3,2 cm

Medication dish, dappen-glass, colored, Ø 3.2 cm



Art.-Nr./No.	Farbe / Color
80-519-00	kristall / crystal
80-519-01	grün / green
80-519-02	rosa / pink
80-519-03	topas / topaz

Porzellan-Schälchen, rund, mit Ausguss

China bowl, round, with spout



Art.-Nr./No.	Durchmesser / Diameter (cm)
80-520-06	Ø 8
80-520-08	Ø 10

Nierenschale, Edelstahl / Kidney bowl, stainless steel



Art.-Nr./No.	Größe / Size (cm)
80-525-17	17,5
80-525-25	25,0

Kornzangen-Behälter, Edelstahl / Forceps holder, stainless steel



Art.-Nr. Art.-No.	Durchmesser Diameter (cm)	Höhe Height (cm)
80-528-13	Ø 5,0	13,5
80-528-18	Ø 5,0	18,0
80-528-20	Ø 9,5	20,0

Kornzangen-Behälter, Glas, Edelstahldeckel mit Ausschnitt, Ø 8 cm, Höhe 20 cm

Forceps holder, glass, stainless steel lid with opening,
Ø 8 cm, height 20 cm



80-530-20

13 Sterilisationssysteme

Sterilization Systems



Norm-Sterilisations-Container, Boden geschlossen

Norm sterilization container, bottom closed

Art.-Nr. Art.-No.	Größe Size	Dimension (außen) Dimension (outside) (mm)
80-631-10	1/2	297 x 274 x 88
80-631-12	1/2	297 x 274 x 123
80-631-14	1/2	297 x 274 x 138
80-631-21	1/2	297 x 274 x 188
80-641-14	3/4	462 x 274 x 138
80-661-12	1	585 x 274 x 123
80-661-14	1	585 x 274 x 138
80-661-21	1	585 x 274 x 188

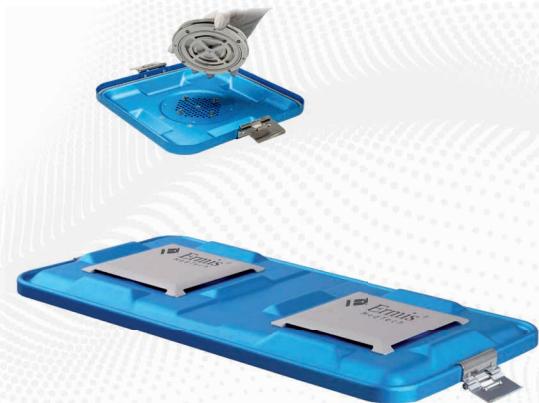

Ventildeckel für Norm-Sterilisations-Container

Valve lid for norm sterilization container

Art.-Nr./No. 1/2 299 x 278 mm	Art.-Nr./No. 3/4 462 x 278 mm	Art.-Nr./No. 1 585 x 278 mm
80-632-00 ●	80-642-00 ●	80-662-00 ●
80-632-01 ●	80-642-01 ●	80-662-01 ●
80-632-02 ●	80-642-02 ●	80-662-02 ●
80-632-03 ●	80-642-03 ●	80-662-03 ●
80-632-04 ●	80-642-04 ●	80-662-04 ●
80-632-05 ●	80-642-05 ●	80-662-05 ●



Edelstahl-Siebkorb, Geflecht, Fallgriffe

Stainless-steel wire basket, sliding handles

Art.-Nr./No.	Größe / Size (mm)
80-671-20	255 x 245 x 50
80-671-25	255 x 245 x 70
80-671-40	405 x 255 x 70
80-671-60	485 x 255 x 70



Aluminium-Kennzeichnungs-Schild, 20 Zeichen, 56 x 17 mm

Coding label, 20 letters, 56 x 17 mm

Art.-Nr./No.	Farbe / Color
80-681-01	schwarz / black
80-681-02	rot / red
80-681-03	braun / brown
80-681-04	grün / green
80-681-05	gelb / yellow
80-681-06	lila / purple
80-681-07	blau / blue

Einweg-Container-Siegel, blau, 100 Stück/Box

Container seal, disposable, blue, 100 pieces/box

80-683-10

Indikator-Klebe-Etikett, Lasche rechts, 100 Stück/Box

Adhesive indicator label, latch right side, 100 pieces/box

80-684-10

Silikonmatte, blau, perforiert, 440 x 230 mm

Silicon mat, blue, perforated, 440 x 230 mm

80-675-00

Klemmschild aus Edelstahl, hitzebeständig,

6 x 4 cm, 25 Stück/Box

Label holder with clip, stainless steel, heat resistant,

6 x 4 cm, 25 pieces/box

80-688-00

14 Laryngoskopie-Basisset 50-950-00

Laryngoscopy basic set 50-950-00

Bestehend aus / Consisting of:

- 50-101-00 1x Bruststütze für Erwachsene, Ring 9 cm, Stützstange 34,5 cm
1x Chest support for adults, ring 9 cm, rod length 34.5 cm
- 50-200-05 1x Operations-Laryngoskop, Gr. 5, für Männer, 17,2 cm, ID 16 mm, OD 29 x 19 mm
1x Surgical laryngoscope, size 5, for men, length 17.2 cm, ID 16 mm, OD 29 x 19 mm
- 50-200-03 1x Operations-Laryngoskop, Gr. 3, für Jugendliche, 17,2 cm, ID 12 mm, AD 21 x 13 mm
1x Surgical laryngoscope, size 3, for juveniles, length 17.2 cm, ID 12 mm, OD 21 x 13 mm
- 50-202-04 1x Operations-Laryngoskop, spreizbar, Gr.4, für Frauen, 17,2 cm, ID 14,5 mm, AD 27 x 15 mm
1x Surgical laryngoscope, spreadable, size 4, for women, 17.2 cm, ID 14.5 mm, OD 27 x 15 mm
- 50-205-36 1x Fiberglas-Lichtträger für starre und spreizbare Laryngoskope Gr. 3-6
1x Fiberglass lightcarrier for rigid and spreadable laryngoscopes size 3-6
- 50-300-00 1x Kleinsasser Handgriff, gewinkelt
1x Kleinsasser handle, angled
- 50-311-23 1x Sichelmesser, gebogene Schneide, Arbeitslänge 22 cm
1x Sickle knife, curved edge, working length 22 cm
- 50-312-23 1x Messer, oval, gerade, Arbeitslänge 22 cm
1x Knife, oval, straight, working length 22 cm
- 50-315-23 1x Messer, golfstockförmig, Arbeitslänge 23 cm
1x Knife, golfstick shaped, working length 23 cm
- 50-317-23 1x Häkchen, stumpf, 90°, Arbeitslänge 22 cm
1x Hook, blunt, 90°, working length 22 cm
- 50-319-23 1x Knotenführer, gerade, Arbeitslänge 23 cm
1x Knot tier, straight, working length 23 cm
- 50-347-20 1x Saugrohr mit Unterbrecher, kniegebogen, seitl. distale Öffnung, 2,0 mm, 25 cm
1x Suction tube with interruptor, distal side opening, angled, 2.0 mm, 25 cm
- 50-353-23 1x Injektionsnadel, bajonett, Arbeitslänge 23 cm
1x Injection needle, bayonet, working length 23 cm
- 80-415-50 1x Monopolares Anschlusskabel für Instrumente, 5 m, passend für Erbe ICC/ACC/Wolf/Storz
1x Monopolar connecting cable for instruments, 5 m, compatible with Erbe ICC/ACC/Wolf/Storz
- 50-501-10 1x Mikrolaryngoskopiezange, drehbar, runde Löffel, 2,0 mm, aufgebogen, mit Spülkanal, 23 cm
1x Microlaryngoscopy forceps, rotatable, round cups, upcurved, 2.0 mm, with irrigation channel, 23 cm
- 50-502-10 1x Mikrolaryngoskopiezange, drehbar, Alligator, aufgebogen, mit Spülkanal, 23,5 cm
1x Microlaryngoscopy forceps, rotatable, alligator, upcurved, with irrigation channel, 23.5 cm
- 50-503-10 1x Mikrolaryngoskopiezange, drehbar, dreieckiges Maul, aufgebogen, mit Spülkanal, 23 cm
1x Microlaryngoscopy forceps, rotatable, triangular tip, upcurved, with irrigation channel, 23 cm
- 50-504-10 1x Mikrolaryngoskopieschere, drehbar, aufgebogen, mit Spülkanal, 23 cm
1x Microlaryngoscopy scissors, rotatable, upcurved, with irrigation channel, 23 cm
- 50-512-01 1x Mikrolaryngoskopiezange mit Spülkanal, runde Löffel, 4,0 mm, gerade, 23 cm
1x Micro laryngeal forceps with irrigation channel, round cups, 4.0 mm, straight, 23 cm
- 50-650-23 1x Laryngoskopie-Nadelhalter mit Spülkanal, mit Sperre, 22 cm
1x Laryngeal needle-holder with irrigation channel, with ratchet, 22 cm
- 50-550-23 1x Mikrolaryngoskopiezange mit Spülkanal, extra fein, runde Löffel, 1,0 mm, gerade, konischer Schaft, 22 cm
1x Micro laryngeal forceps with irrigation channel, very delicate, round cups, 1.0 mm, traight, conical shaft, 22 cm
- 50-560-23 1x Mikrolaryngoskopiezange mit Spülkanal, extra fein, Hechtmaul, 1,0 mm, gerade, konischer Schaft, 22 cm
1x Micro laryngeal forceps with irrigation channel, very delicate, alligator jaw, 1.0 mm, straight, conical shaft, 22 cm
- 50-570-23 1x Mikrolaryngoskopieschere mit Spülkanal, extra fein, 1,0 mm, gerade, konischer Schaft, 22 cm
1x Micro laryngeal scissors with irrigation channel, very delicate, 1.0 mm, straight, conical shaft, 22 cm

Ergänzung 50-950-99

Supplement 50-950-99

- 50-416-23 1x Monopolare Koagulationszange, drehbar, gefenstert, oval, gerade, Rauchabsaugung, Schaft 3,0 mm, 23,5 cm
1x Monopolar coagulation forceps, rotatable, fenestrated, oval, straight, smoke evacuation, shaft 3.0 mm, 23.5 cm
- 50-240-00 5x Endoragard Zahnschutz, doppelseitig
5x Endoragard teeth protector, double sided
- 80-661-14 1x Norm-Sterilisations-Container, Boden geschlossen, 585 x 274 x 138 mm
1x Norm sterilization container, bottom closed, 585 x 274 x 138 mm
- 80-662-00 1x Ventildeckel, silber, für Container 80-661-14, 585 x 278 mm
1x Valve lid, silver, for container 80-661-14, 585 x 278 mm
- 80-671-60 1x Edelstahl-Siebkorb, Geflecht, Fallgriffe, 485 x 255 x 70 mm
1x Stainless steel wire basket, sliding handles, 485 x 255 x 70 mm
- 80-681-03 1x Aluminium-Kennzeichnungs-Schild, braun, 20 Zeichen
1x Aluminium tag, brown, 20 letter

Supplement for sales in EU (outside the EU only on request)

14 Laser-Set für Erwachsene 50-960-00

Laser set for adults 50-960-00

Bestehend aus / Consisting of:

- 50-215-05 1x Laser-Laryngoskop Größe 5 für Männer
1x Laser laryngoscope size 5 for men
- 50-215-03 1x Laser-Laryngoskop Größe 3 für Jugendliche
1x Laser laryngoscope size 3 for juveniles
- 50-217-36 1x Fiberglas-Lichtträger für Laserlaryngoskope Größen 3-6
1x Fiberglass lightcarrier for laser laryngoscopes sizes 3-6
- 50-218-17 1x Rauchabsaugrohr für Laserlaryngoskope Größen 3-7
1x Smoke evacuation tube for laser laryngoscopes sizes 3-7
- 50-347-20 1x Saugrohr mit Unterbrecher, kniegebogen, seitlich distale Öffnung 2,0 mm, 25 cm
1x Suction tube with interruptor, angled, distal side opening 2.0 mm, 25 cm
- 50-349-30 1x Saugrohr mit Unterbrecher, Spitze geschlossen, zwei seitliche Öffnungen 3,0 mm, 25 cm
1x Suction tube with interruptor, tip closed, two side openings 3.0 mm, 25 cm
- 80-415-50 1x Monopolares Anschlusskabel für Instrumente, 5 m, passend für Erbe ICC/ACC/Wolf/Storz
1x Monopolar connecting cable for instruments, 5 m, compatible with Erbe ICC/ACC/Wolf/Storz
- 80-501-01 1x Metallschale B1, Ø 4,0 cm, Höhe 1,9 cm, 20 ml
1x Metal bowl B1, Ø 4.0 cm, height 1.9 cm, 20 ml

Bestehend aus / Consisting of:

- 50-215-02 1x Laser-Laryngoskop, Gr. 2, schwarz, für Kinder, 15,2 cm, ID 11 mm, AD 20,5 x 13 mm
1x Laser laryngoscope, size 2, black, for children, 15.2 cm, ID 11 mm, OD 20.5 x 13 mm
- 50-217-12 1x Fiberglas-Lichtträger für Laser-Laryngoskope Gr. 1 und 2
1x Fiberglass lightcarrier for laser laryngoscopes size 1 and 2
- 50-218-17 1x Rauchabsaugrohr für Laserlaryngoskope Größen 3-7
1x Smoke evacuation tube for laser laryngoscopes sizes 3-7
- 50-347-20 1x Saugrohr mit Unterbrecher, kniegebogen, seitlich distale Öffnung 2,0 mm, 25 cm
1x Suction tube with interruptor, angled, distal side opening 2.0 mm, 25 cm
- 50-580-18 1x Mikrolaryngoskopiezange mit Spülkanal, extra fein, Herzform, 1,0 mm, rechts gebogen, konischer Schaft, 17 cm
1x Micro laryngeal forceps with irrigation channel, very delicate, heartshaped jaw, 1.0 mm, right curved, conical shaft, 17 cm
- 50-581-18 1x Mikrolaryngoskopiezange mit Spülkanal, extra fein, Herzform, 1,0 mm, links gebogen, konischer Schaft, 17 cm
1x Micro laryngeal forceps with irrigation channel, very delicate, heartshaped jaw, 1.0 mm, left curved, conical shaft, 17 cm
- 80-501-01 1x Metallschale B1, Ø 4,0 cm, Höhe 1,9 cm, 20 ml
1x Metal bowl B1, Ø 4.0 cm, height 1.9 cm, 20 ml

Ergänzung 50-960-99

Supplement 50-960-99

- 50-412-23 1x Monopolare Koagulationszange, drehbar, gerieft, gebogen, Rauchabsaugung, Schaft 3,0 mm, 23,5 cm
1x Monopolar coagulation forceps, serrated, curved, smoke evacuation, shaft 3.0 mm, 23.5 cm
- 50-240-00 1x Endoragard Zahnschutz, doppelseitig
1x Endoragard teeth protector, double sided
- 50-416-23 1x Monopolare Koagulationszange, drehbar, gefenestert, oval, gerade, Rauchabsaugung, Schaft 3,0 mm, 23,5 cm
1x Monopolar coagulation forceps, rotatable, fenestrated, oval, straight, smoke evacuation, shaft 3.0 mm, 23.5 cm
- 80-661-14 1x Norm-Sterilisations-Container, Boden geschlossen, 585 x 274 x 138 mm
1x Norm sterilization container, bottom closed, 585 x 274 x 138 mm
- 80-662-00 1x Ventildeckel, silber, für Container 80-661-14, 585 x 278 mm
1x Valve lid, silver, for container 80-661-14, 585 x 278 mm
- 80-671-60 1x Edelstahl-Siebkorb, Geflecht, Fallgriffe, 485 x 255 x 70 mm
1x Stainless steel wire basket, sliding handles, 485 x 255 x 70 mm
- 80-681-02 1x Aluminium-Kennzeichnungs-Schild, rot, 20 Zeichen
1x Aluminium tag, red, 20 letter

Supplement for sales in EU (outside the EU only on request)

14 Laser-Set für Kinder 50-970-00

Laser set for children 50-970-00

- 80-415-50 1x Monopolares Anschlusskabel für Instrumente, 5 m, passend für Erbe ICC/ACC/Wolf/Storz
1x Monopolar connecting cable for instruments, 5 m, compatible with Erbe ICC/ACC/Wolf/Storz

Ergänzung 50-970-99

Supplement 50-970-99

- 50-412-23 1x Monopolare Koagulationszange, drehbar, gerieft, gebogen, Rauchabsaugung, Schaft 3,0 mm, 23,5 cm
1x Monopolar coagulation forceps, serrated, curved, smoke evacuation, shaft 3.0 mm, 23.5 cm
- 50-240-00 1x Endoragard Zahnschutz, doppelseitig
1x Endoragard teeth protector, double sided
- 80-631-14 1x Norm-Sterilisations-Container, Boden geschlossen, 297 x 274 x 138 mm
1x Norm sterilization container, bottom closed, 297 x 274 x 138 mm
- 80-632-00 1x Ventildeckel, silber, für Container 80-631-xx, 297 x 274 mm
1x Valve lid, silver, for container 80-631-xx, 297 x 274 mm
- 80-671-20 1x Edelstahl-Siebkorb, Geflecht, Fallgriffe, 255 x 245 x 50 mm
1x Stainless steel wire basket, sliding handles, 255 x 245 x 50 mm
- 80-681-01 1x Aluminium-Kennzeichnungs-Schild, schwarz, 20 Zeichen
1x Aluminium tag, black, 20 letter



14 Pädiatrisches Laryngoskopie-Basisset 50-980-00

Basic set for pediatric laryngoscopy 50-980-00

Bestehend aus / Consisting of:

- 50-101-00 1x Bruststütze für Erwachsene, Ring 9 cm, Stützstange 34,5 cm
1x Chest support for adults, ring 9 cm, rod length 34.5 cm
- 50-101-10 1x Stützstange für Bruststütze, Ring 9 cm, 25 cm, für Kinder
1x Rod for chest support, ring 9 cm, 25 cm, for children
- 50-215-01 1x Laser-Laryngoskop, Gr. 1, schwarz, für Kleinkinder, 13,5 cm, ID 11 mm, AD 20 x 12 mm
1x Laser laryngoscope, size 1, black, for small children, 13.5 cm, ID 11 mm, OD 20 x 12 mm
- 50-215-02 1x Laser-Laryngoskop, Gr. 2, schwarz, für Kinder, 15,2 cm, ID 11 mm, AD 20,5 x 13 mm
1x Laser laryngoscope, size 2, black, for children, 15.2 cm, ID 11 mm, OD 20.5 x 13 mm
- 50-217-12 1x Fiberglas-Lichtträger für Laser-Laryngoskope Gr. 1 und 2
1x Fiberglass lightcarrier for laser laryngoscopes size 1 and 2
- 50-300-00 1x Kleinsasser Handgriff, gewinkelt
1x Kleinsasser handle, angled
- 50-311-23 1x Sichelmesser, gebogene Schneide, Arbeitslänge 22 cm
1x Sickle knife, curved edge, working length 22 cm
- 50-318-23 1x Häkchen, scharf, retrograd, Arbeitslänge 23 cm, Gesamtlänge 25 cm
1x Hook, sharp, backwards, working length 23 cm, total length 25 cm
- 50-347-20 1x Saugrohr mit Unterbrecher, kniegebogen, seitl. distale Öffnung, 2,0 mm, 25 cm
1x Suction tube with interruptor, distal side opening, angled, 2.0 mm, 25 cm
- 50-551-23 1x Mikrolaryngoskopiezange mit Spülkanal, extra fein, runde Löffel, 1,0 mm, rechts gebogen, konischer Schaft, 22 cm
1x Micro laryngeal forceps with irrigation channel, very delicate, round cups, 1.0 mm, right curved, conical shaft, 22 cm
- 50-552-23 1x Mikrolaryngoskopiezange mit Spülkanal, extra fein, runde Löffel, 1,0 mm, links gebogen, konischer Schaft, 22 cm
1x Micro laryngeal forceps with irrigation channel, very delicate, round cups, 1.0 mm, left curved, conical shaft, 22 cm
- 50-571-23 1x Mikrolaryngoskopieschere mit Spülkanal, extra fein, 1,0 mm, rechts gebogen, konischer Schaft, 22 cm
1x Micro laryngeal scissors with irrigation channel, very delicate, 1.0 mm, right curved, conical shaft, 22 cm
- 50-572-23 1x Mikrolaryngoskopieschere mit Spülkanal, extra fein, 1,0 mm, links gebogen, konischer Schaft, 22 cm
1x Micro laryngeal scissors with irrigation channel, very delicate, 1.0 mm, left curved, conical shaft, 22 cm
- 50-580-23 1x Mikrolaryngoskopiezange mit Spülkanal, extra fein, Herzform, 1,0 mm, rechts gebogen, konischer Schaft, 22 cm
1x Micro laryngeal forceps with irrigation channel, very delicate, heartshaped jaw, 1.0 mm, right curved, conical shaft, 23 cm
- 50-581-23 1x Mikrolaryngoskopiezange mit Spülkanal, extra fein, Herzform, 1,0 mm, links gebogen, konischer Schaft, 22 cm
1x Micro laryngeal forceps with irrigation channel, very delicate, heartshaped jaw, 1.0 mm, left curved, conical shaft, 23 cm
- 50-550-18 1x Mikrolaryngoskopiezange mit Spülkanal, extra fein, runde Löffel, 1,0 mm, gerade, konischer Schaft, 17 cm
1x Micro laryngeal forceps with irrigation channel, very delicate, round cups, 1.0 mm, straight, conical shaft, 17 cm
- 50-580-18 1x Mikrolaryngoskopiezange mit Spülkanal, extra fein, Herzform, 1,0 mm, rechts gebogen, konischer Schaft, 17 cm
1x Micro laryngeal forceps with irrigation channel, very delicate, heartshaped jaw, 1.0 mm, right curved, conical shaft, 17 cm
- 50-581-18 1x Mikrolaryngoskopiezange mit Spülkanal, extra fein, Herzform, 1,0 mm, links gebogen, konischer Schaft, 17 cm
1x Micro laryngeal forceps with irrigation channel, very delicate, heartshaped jaw, 1.0 mm, left curved, conical shaft, 17 cm
- 80-415-50 1x Monopolares Anschlusskabel für Instrumente, 5 m, passend für Erbe ICC/ACC/Wolf/Storz
1x Monopolar connecting cable for instruments, 5 m, compatible with Erbe ICC/ACC/Wolf/Storz

Ergänzung 50-980-99

Supplement 50-980-99

- 50-240-00 1x Endoragard Zahnschutz, doppelseitig
1x Endoragard teeth protector, double sided
- 50-412-23 1x Monopolare Koagulationszange, drehbar, gerieft, gebogen, Rauchabsaugung, Schaft 3,0 mm, 23,5 cm
1x Monopolar coagulation forceps, serrated, curved, smoke evacuation, shaft 3.0 mm, 23.5 cm
- 80-631-14 1x Norm-Sterilisations-Container, Boden geschlossen, 297 x 274 x 138 mm
1x Norm sterilization container, bottom closed, 297 x 274 x 138 mm
- 80-632-00 1x Ventildeckel, silber, für Container 80-631-xx, 297 x 274 mm
1x Valve lid, silver, for container 80-631-xx, 297 x 274 mm
- 80-671-20 1x Edelstahl-Siebkorb, Geflecht, Fallgriffe, 255 x 245 x 50 mm
1x Stainless steel wire basket, sliding handles, 255 x 245 x 50 mm
- 80-681-07 1x Aluminium-Kennzeichnungs-Schild, blau, 20 Zeichen
1x Aluminium tag, blue, 20 letter

Supplement for sales in EU (outside the EU only on request)



Alphabetisches Inhaltsverzeichnis

Alphabetical Index

Bipolare Koagulationselektrode.....	16	Adhesive indicator label.....	29
Bipolares Anschlusskabel.....	17	Angled endoscope HD.....	6
Bruststütze.....	5	Basic set for paediatric laryngoscopy.....	32
Codier-Schild.....	29	Basket.....	28
Container-Siegel.....	29	Bipolar coagulation electrode.....	16
Endoragard Zahnschutz.....	12	Bipolar connecting cable.....	17
Fiberglas-Lichtträger.....	9, 11	Chest support.....	5
Handgriff.....	11	China bowl.....	27
Heermann Handgriff.....	13	Coding label.....	29
Holinger Laryngoskop.....	11	Container seal.....	29
Häkchen.....	14	Cotton carrier.....	15
Indikator-Klebe-Etikett.....	29	Endoragard teeth protector.....	12
Inject-Timer-Kanüle.....	9, 11	Fiberglass lightcarrier.....	9, 11
Injektionsnadel.....	15	Forceps holder.....	27
Jackson Laryngoskop.....	11	Handle.....	9, 11
Kleinsasser Handgriff.....	13	Heermann handle.....	13
Klemmschild.....	29	Holinger Laryngoscope.....	11
Knotenführer.....	14	Hook.....	14
Kornzangen-Behälter.....	27	Inject-Timer cannula.....	9, 11
Laryngoskopie-Basisset.....	30	Injection needle.....	15
Laryngoskopie-Nadelhalter.....	24	Jackson Laryngoscope.....	11
Laser-Laryngoskop.....	10	Kidney bowl.....	27
Laser-Sets.....	31	Kleinsasser handle.....	13
LED-Leuchtgriffe.....	25	Knives.....	13, 14
Lösungsschale.....	26	Knot tier.....	14
Medasil Zahnschutz.....	12	Label holder with clip.....	29
Medikamenten-Schälchen.....	26 - 27	Laryngeal needle-holder.....	24
Medizinbecher.....	26	Laryngoscopy Basic Set.....	30
Messer.....	13, 14	Laser laryngoscope.....	10
Metallschale.....	26	Laser Sets.....	31
Mikrolaryngoskopieschere mit Spülkanal.....	19, 21, 23 - 24	LED light handles.....	25
Mikrolaryngoskopiezange, drehbar.....	18, 19	Medasil teeth protector.....	12
Mikrolaryngoskopiezange mit Spülkanal.....	18 - 22	Medication dish.....	26 - 27
Monopolare Koagulationszange.....	16	Medicine cup.....	26
Monopolares Anschlusskabel.....	17	Metal bowl.....	26
Nierenschale.....	27	Micro laryngeal forceps, rotatable.....	18, 19
Norm-Sterilisations-Container.....	28	Micro laryngeal forceps w. irrigation channel.....	18 - 22
Operations-Laryngoskop.....	7 - 8	Micro laryngeal scissors w. irrigation channel.....	19, 21, 23 - 24
Pädiatrisches Laryngoskopie-Basisset.....	32	Monopolar coagulation forceps.....	16
Petrischale.....	26	Monopolar connecting cable.....	17
Porzellan-Schälchen.....	27	Norm sterilization container.....	28
Rauchabsaugrohr.....	9, 11	Petri dish.....	26
Saugrohr.....	15	Probe.....	14
Siebkorb.....	28	Sickle knife.....	13
Sichelmesser.....	13	Smoke evacuation tube.....	9, 11
Stimmband-Spreizer.....	25	Solution bowl.....	26
Sonde.....	14	Surgical laryngoscope.....	7 - 8
Tablettenschale.....	26	Suction tube.....	15
Umstechungsnadel.....	14	Suture needle.....	14
Ventildeckel für Norm-Sterilisations-Container.....	28	Tablet dish.....	26
Videolaryngoskop.....	6	Teeth protector, metal.....	12
Watteträger.....	15	Valve lid for norm sterilization container.....	28
Winkeloptik HD.....	6	Vocal cord spreader.....	25
Zahnschutz aus Metall.....	12	Video laryngoscope.....	6

10-722-13	13	50-250-00	12	50-540-03-L	21	80-503-03	26
40-100-70	18	50-300-00	13	50-540-04-L	21	80-504-05	26
40-100-90	18	50-301-23	13	50-550-18	22	80-506-30	26
40-103-70	18	50-310-23	13	50-550-23	22	80-507-40	26
40-103-90	18	50-311-23	13	50-551-18	22	80-509-75	26
40-107-70	18	50-312-23	13	50-551-23	22	80-512-00	26
40-110-00	18	50-313-23	13	50-552-18	22	80-515-06	26
40-110-30	18	50-314-23	13	50-552-23	22	80-515-08	26
40-110-70	18	50-315-23	14	50-553-18	22	80-515-10	26
40-112-00	18	50-316-23	14	50-553-23	22	80-517-00	26
40-112-30	18	50-317-23	14	50-560-18	22	80-519-00	27
40-112-70	18	50-318-23	14	50-560-23	22	80-519-01	27
50-101-00	5	50-319-23	14	50-561-18	22	80-519-02	27
50-101-10	5	50-320-23	14	50-561-23	22	80-519-03	27
50-101-20	5	50-321-23	14	50-562-18	22	80-520-06	27
50-101-30	5	50-330-40	9	50-562-23	22	80-520-08	27
50-101-40	5	50-345-23	15	50-570-18	23	80-525-17	27
50-150-00	6	50-347-20	15	50-570-23	23	80-525-25	27
50-155-00	6	50-347-25	15	50-571-18	23	80-528-13	27
50-200-01	7	50-347-30	15	50-571-23	23	80-528-18	27
50-200-02	7	50-349-30	15	50-572-18	23	80-528-20	27
50-200-03	7	50-351-23	15	50-572-23	23	80-530-20	27
50-200-04	7	50-353-23	15	50-573-18	23	80-631-10	28
50-200-05	7	50-365-27	16	50-573-23	23	80-631-12	28
50-200-06	8	50-411-23	16	50-580-01	24	80-631-14	28
50-200-07	8	50-412-23	16	50-580-02	24	80-631-21	28
50-202-01	7	50-414-23	16	50-580-01-L	24	80-632-00	28
50-202-02	7	50-416-23	16	50-580-02-L	24	80-632-01	28
50-202-03	7	50-501-10	19	50-580-18	22	80-632-02	28
50-202-04	7	50-501-10-L	19	50-580-23	22	80-632-03	28
50-202-05	7	50-502-10	19	50-581-18	22	80-632-04	28
50-202-06	8	50-502-10-L	19	50-581-23	22	80-632-05	28
50-202-07	8	50-503-10	19	50-590-23	23	80-641-14	28
50-205-12	9	50-503-10-L	19	50-591-23	23	80-642-00	28
50-205-36	9	50-504-10	19	50-592-23	23	80-642-01	28
50-205-70	9	50-504-10-L	19	50-593-23	23	80-642-02	28
50-207-17	9	50-510-01	20	50-649-23	24	80-642-03	28
50-209-17	9	50-510-01-L	20	50-650-23	24	80-642-04	28
50-215-01	10	50-510-02	20	50-652-23	24	80-642-05	28
50-215-02	10	50-510-03	20	50-950-00	30	80-661-12	28
50-215-03	10	50-510-04	20	50-960-00	31	80-661-14	28
50-215-04	10	50-510-05	20	50-970-00	31	80-661-21	28
50-215-05	10	50-510-06	20	50-980-00	32	80-662-00	28
50-215-06	10	50-512-01	20	70-211-00	25	80-662-01	28
50-215-07	10	50-512-02	20	70-211-01	25	80-662-02	28
50-217-12	11	50-512-03	20	70-211-10	25	80-662-03	28
50-217-36	11	50-512-04	20	70-211-20	25	80-662-04	28
50-217-70	11	50-516-01	20	70-211-30	25	80-662-05	28
50-218-17	11	50-516-02	20	70-211-40	25	80-671-20	28
50-219-17	11	50-516-03	20	70-211-50	25	80-671-25	28
50-229-01	11	50-516-04	20	80-316-50	17	80-671-40	28
50-229-02	11	50-520-01	21	80-317-30	17	80-671-60	28
50-229-03	11	50-520-02	21	80-317-50	17	80-675-00	29
50-232-01	11	50-520-03	21	80-318-30	17	80-681-01	29
50-232-02	11	50-520-04	21	80-318-50	17	80-681-02	29
50-232-03	11	50-530-01	21	80-319-30	17	80-681-03	29
50-232-23	14	50-530-02	21	80-319-50	17	80-681-04	29
50-235-00	11	50-530-03	21	80-414-50	17	80-681-05	29
50-240-00	12	50-540-01	21	80-415-50	17	80-681-06	29
50-245-00	12	50-540-02	21	80-501-01	26	80-681-07	29
50-245-01	12	50-540-03	21	80-501-02	26	80-683-10	29
50-245-02	12	50-540-04	21	80-501-03	26	80-684-10	29
50-245-03	12	50-540-01-L	21	80-501-04	26	80-688-00	29





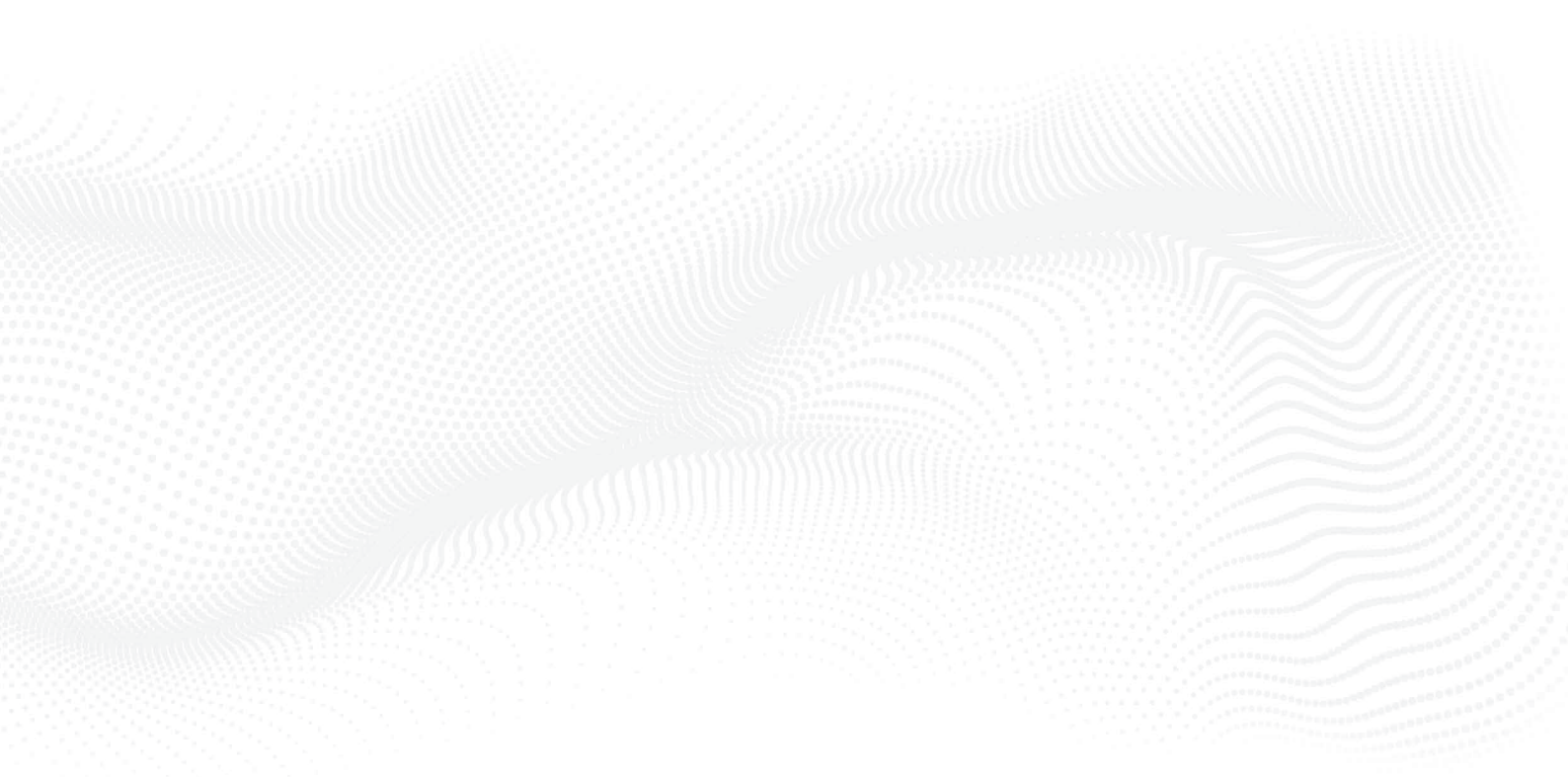

Umrechnungstabelle - Ch/Fr - mm - inch

Conversion table - Ch/Fr - mm - inch

Charrière (CH) French (F)	mm	Inch
1	0,33	0,013
2	0,67	0,025
3	1,00	0,039
4	1,33	0,051
5	1,67	0,065
6	2,00	0,079
7	2,33	0,092
8	2,67	0,105
9	3,00	0,118
10	3,33	0,131
11	3,67	0,144
12	4,00	0,156
13	4,33	0,170
14	4,67	0,184
15	5,00	0,197
16	5,33	0,210
17	5,67	0,223
18	6,00	0,237
19	6,33	0,249
20	6,67	0,263
21	7,00	0,276
22	7,33	0,288
23	7,67	0,302
24	8,00	0,315
25	8,33	0,328
26	8,67	0,341
27	9,00	0,354
28	9,33	0,367
29	9,67	0,380
31	10,23	0,407
32	10,67	0,420
34	11,33	0,446
36	12,00	0,472
38	12,67	0,494
40	13,33	0,520
45	15,00	0,591



© 2023 by SPIGGLE & THEIS Medizintechnik GmbH

Änderungen und Irrtümer – einschließlich Bilder - vorbehalten.
Produktsortiment kann pro Land abweichen.

Modifications and errors - including pictures - reserved.
Product range might vary per country.



Burghof 14 · 51491 Overath · Germany
Phone: +49 2206 90 81 - 0
Fax: +49 2206 90 81 - 13
info@spiggle-theis.com
www.spiggle-theis.com