

Spectar P

The Adaptive Imaging System for Advanced Endoscopy



 **3D**  **4K**
Full HD

See more than others.





Spectar P – A new approach in endoscopic imaging

XION has developed a novel adaptive endoscopic imaging system, wherein just a single device comprehensively provides the features required for performing all endoscopic examinations and interventions, thus overcoming the inadequacies of conventional techniques and leading to completely new opportunities on the basis of latest, cutting-edge technologies.

SPECTAR P – THE UNIVERSAL CAMERA SYSTEM

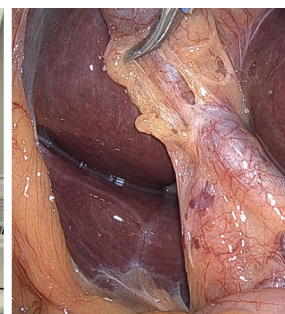
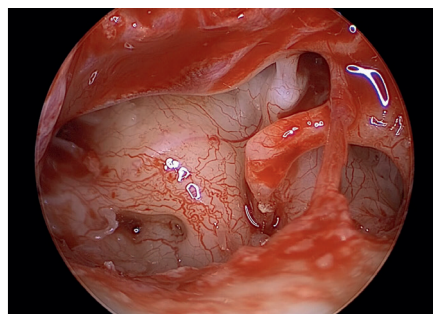
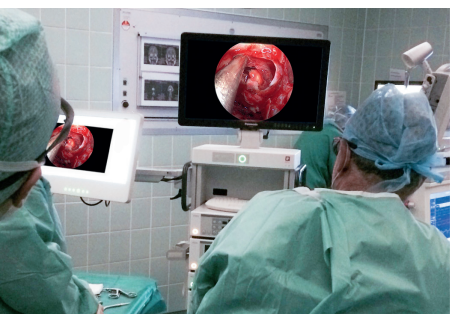

Spectar P is the universal camera system for all current and future 2D and 3D endoscopic applications. The revolutionary technology of the Spectar P Camera System is designed for native sensor resolutions up to 4K and for demanding 3D endoscopic applications, thus offering completely new possibilities for rigid and flexible endoscopy while maintaining the familiar ease of use.

SPECTAR P – PIONEERING, REVOLUTIONARY CAMERA TECHNOLOGY

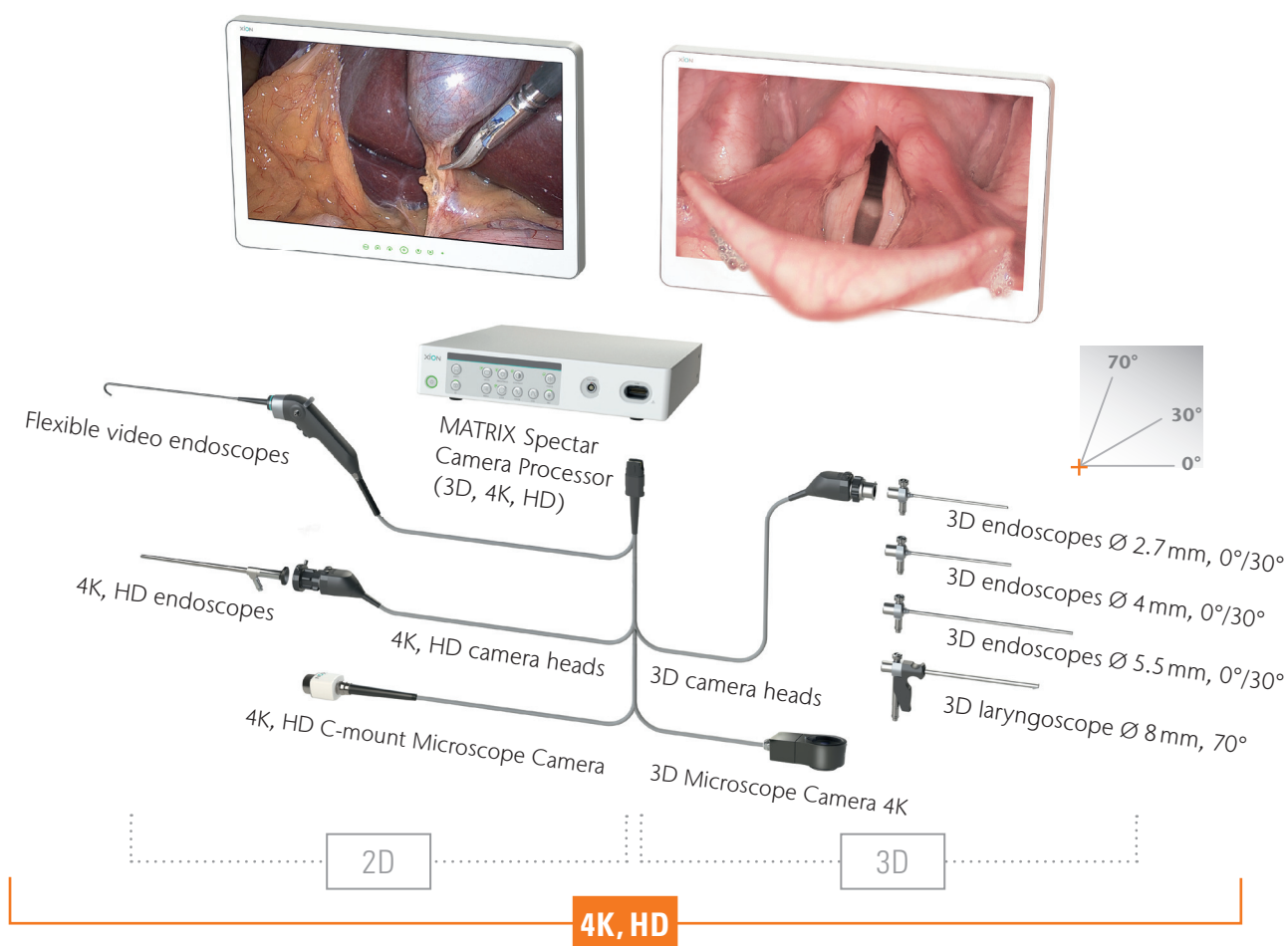

Spectar P meets all the requirements of modern endoscopy. The MATRIX P Spectar Processor provides the features necessary to operate all current and future camera heads, all rigid and flexible video endoscopes. Innovative, proprietary image processing routines facilitate excellent image quality for 2D and 3D endoscopy at sensor resolutions up to 4K.

Modular, cost-effective, future-proof

- Multifunctional, future-proof camera platform
- Long-term expandable for a wide range of 2D and 3D applications
- A unique, universal connector that enables interchangeability of all camera heads and video endoscopes within the Spectar platform
- Financial benefits resulting from compatibility of the individual components and unrestricted expandability – no more expensive new purchases of individual solutions necessary
- High investment security
- Uniform operating concept
- Options for standardization across multiple disciplines
- Customizable settings for efficient work processes
- Detailed and clear on-screen display



SPECTAR – HIGHEST LEVEL 2D-ENDOSCOPY



4K technology – four times the resolution of HD – and the extended colour space make it much easier to detect vascular and tissue structures. Anatomical subtleties are represented in all their complexity and colour fidelity, clear and precise, and the user benefits from safe and more fatigue-free work.

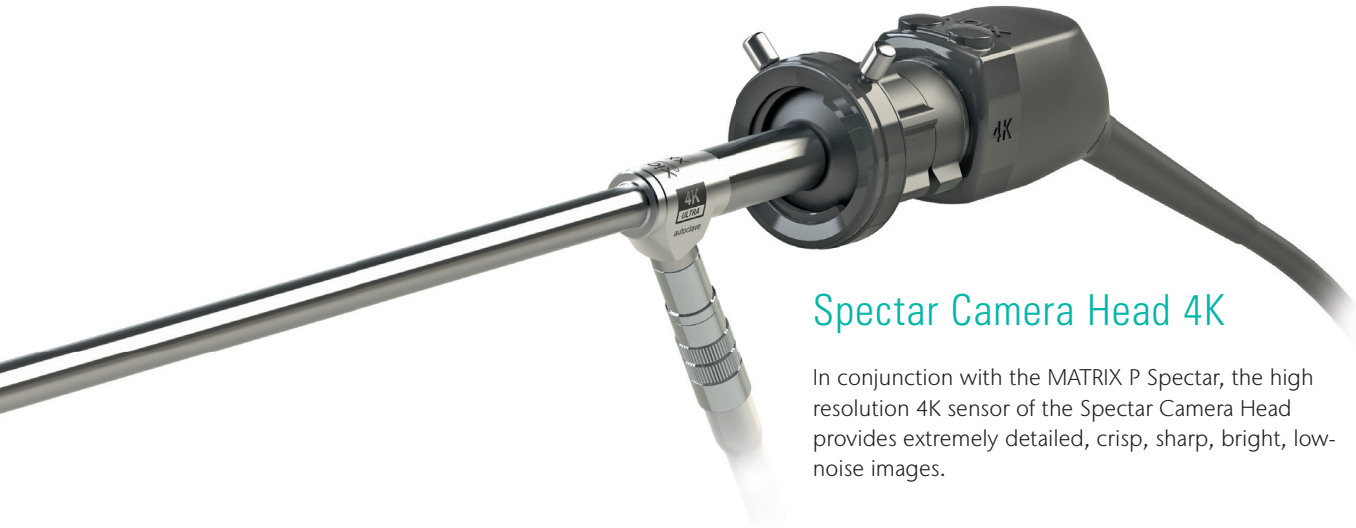

Spectar Camera Head 4K

In conjunction with the MATRIX P Spectar, the high resolution 4K sensor of the Spectar Camera Head provides extremely detailed, crisp, sharp, bright, low-noise images.

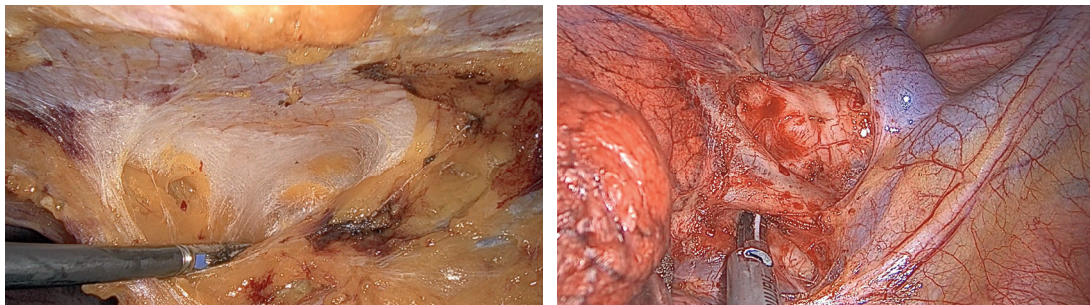

Ultra Endoscopes for 4K Endoscopy

XION offers excellent endoscopes for optimal 4K image quality; in combination with the MATRIX Spectar Camera System, these provide highest image quality, with clear, bright and homogeneous illumination, great depth of field and a very large colour space.





SPECTAR – 3D ENDOSCOPY

The Spectar P Camera System provides the features necessary to create highest-quality 3D images – now even with thin endoscopes. The overall modular concept and the economic endoscope attachments make it possible to expand the MATRIX P Spectar Camera Processor to a highly advance 3D endoscope system at just moderate cost.



Spectar 3D Camera Head

In conjunction with XION 3D Endoscope attachments, the extremely compact, lightweight Spectar 3D Camera Head provides brilliant 3D images with endoscope outer diameters upwards from 2.7 mm. The XION Sterile Adapter between the 3D camera head and the endoscope attachment ensures that the endoscope is held securely and sterile camera drapes can be attached easily. It is therefore possible to easily change the optics under sterile conditions.

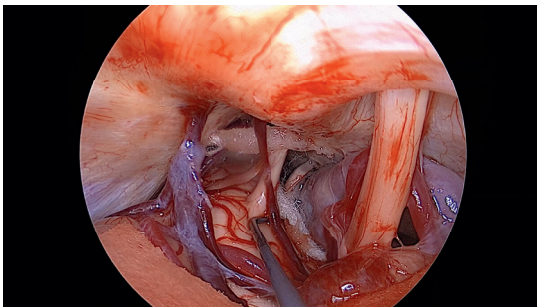

3D Endoscope Attachments

Different lenses for different applications can be selected for the Spectar 3D Endoscopy System.

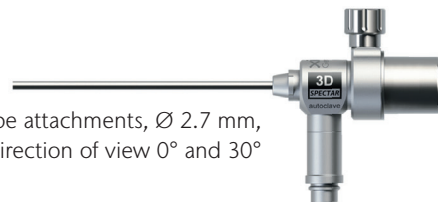

3D endoscope attachments, Ø 2.7 mm, direction of view 0° and 30°

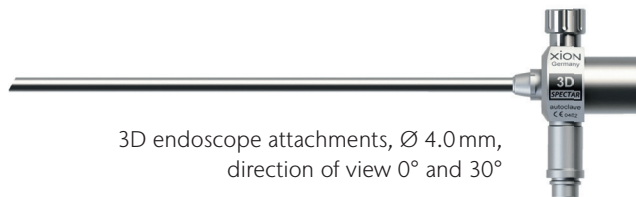

3D endoscope attachments, Ø 4.0 mm, direction of view 0° and 30°



3D laparoscope attachments, Ø 5.5 mm, direction of view 0° and 30°



SPECTAR – MICROSCOPY CAMERAS

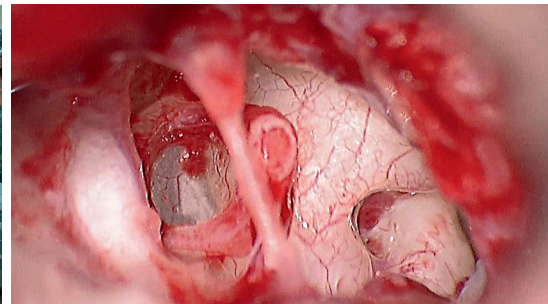
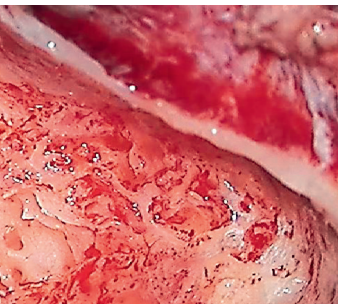

Spectar C-mount Camera Head for microscopy

The compact Spectar C-mount Camera Head can be easily mounted on any surgical microscope. This ensures highest-quality for video recordings and for co-observation.

The Spectar Camera Head is available in two versions: 4K and HD.



Spectar 3D Microscope Camera 4K

XION's Spectar 3D Microscope Camera enables 3D co-observation of the microscope image on a 3D monitor as well as 3D video recording. This useful extension of the MATRIX Spectar System can be combined with most surgical microscopes. The Spectar 3D Microscope Camera is mounted between the binocular tube and the surgical microscope. The beam splitter integrated in the microscope camera transmits a bright and clear microscope image to the binocular tube and to the high-resolution image sensor.

The Spectar 3D Microscope Camera empowers users to perform combined 3D microscopy and 3D or 2D endoscopy work, thanks to the rapid-switching feature for changing between endoscopic and microscopic image capture on a jointly used camera processor. This not only saves time, costs and space in the operating room, a great feature is now that the image data from microscopy and endoscopy can be processed, displayed and stored on one and the same device. This provides a better overview and more effective working.



SPECTAR – FLEXIBLE VIDEO ENDOSCOPES

The unique and innovative technology of the Spectar camera platform facilitates operating flexible HD video endoscopes. The features provided facilitate more exact reproduction of surface structures and more precise treatment.



Spectar Video Nasopharyngoscope XN HD, XN, XN P20 and XN S

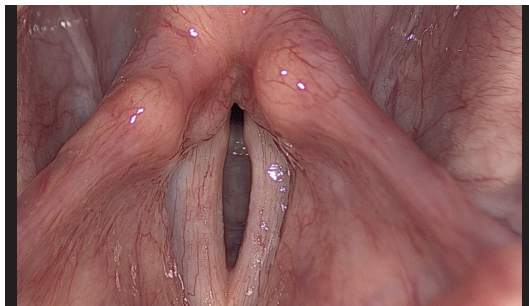

Spectar flexible Video Endoscopes deliver bright, high-resolution, homogeneously illuminated, high-contrast images with excellent depth of field. These video endoscopes feature a combination of highest resolution and convenient handling.

The camera sensor, light source, optics, microphone and control keys are integrated in a single instrument and connected to the Spectar Camera Processor by means of just a single cable. Because the LED lighting is integrated in the handle, a separate light source is no longer necessary!

The handle is ergonomically shaped, and its symmetrical design allows it to be used by both left- and right-handed users. Spectar Video Nasopharyngoscopes incorporate programmable function keys and are suitable for both mechanical as well as manual reprocessing.

- XN HD Ø 3.6 mm
- XN P Ø 2.7 mm
- XN P20 Ø 4.8 mm, working channel Ø 2 mm
- XN S Ø 3.4 mm

Spectar endoscopy in 4K – for brilliant, accurately detailed imaging

There is an increasing need and expectation for clearer and sharper visualization in the field of endoscopy and minimal invasion.

Crucial factors for this are

- High image resolution
- Natural colour reproduction
- Maximum image sharpness
- Optimum brightness distribution curve
- Homogeneous illumination

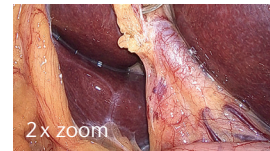
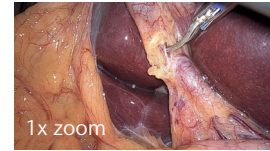
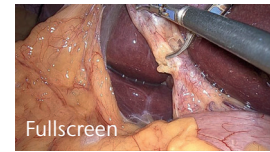

3D endoscopy with highest imaging quality

The challenge, particularly in the case of very thin 3D endoscopes, is to guarantee a precisely adjusted stereo image throughout the entire course of the examination and/or the surgical intervention. An extremely complex process performs the following automatic, real-time corrections:

- Optical distortion
- Magnification differences between the optical channels
- Horizontal and vertical disparity

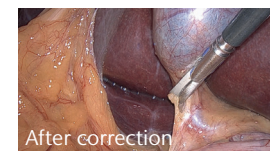

PIET – Individual and situational options for visualization

XION's professional image enhancement technology (PIET) extends the system by adding three situational visualization technologies. Modes PIET lumino, PIET chromo and PIET spectro are available in all resolutions (HD, 4K) as well as in 2D and 3D endoscopy.

Standard

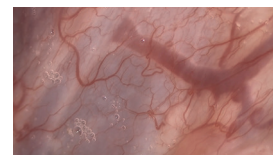

PIET

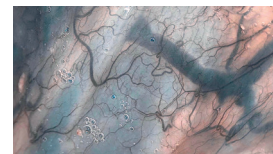
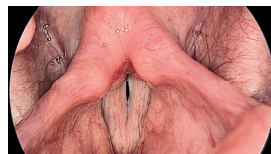

PIET lumino

Both bright as well as dark areas are equally well represented

PIET chromo

Details are highlighted, and the colour contrast is intensified.

PIET spectro

By shifting the colour spectrum, tissue structures are displayed in a more differentiated manner.



MATRIX DS Data Station

The MATRIX DS Data Station with integrated DiVAS software, which is approved for use in medical environments, forms the basis for digital recording, managing and evaluating all patient data in XION Endoscopy Systems. It is an integral part of the archiving and analysis systems as well as all integrated operating room solutions.

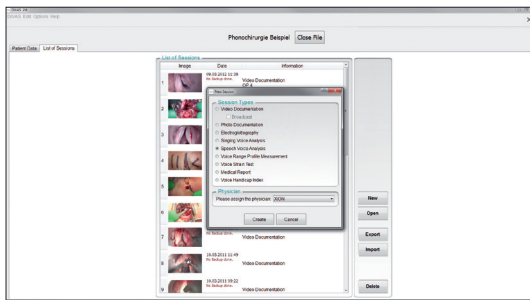

DiVAS Basic / Patient Management module

The Basic / Patient Management module is the basis and essential minimum requirement for using DiVAS. The findings are digitally archived in the respective patient file in the form of image, video, measurement or audio data, spreadsheets or office documents. These data can be exported from sessions and also imported into them, so that they are available for external evaluations, scientific papers and publications.

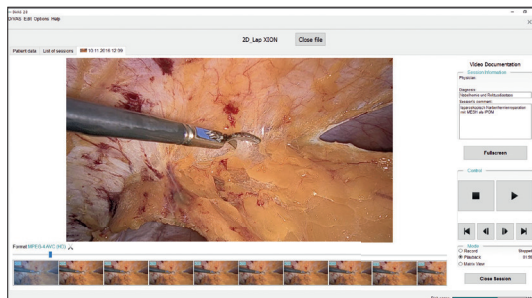

DiVAS Video Documentation module

While the video image is being displayed live on the monitor, the data can be recorded in background at the resolution provided by the camera. The videos can be subsequently viewed individually or in parallel, and the images can be individually analysed, cut, archived or exported.

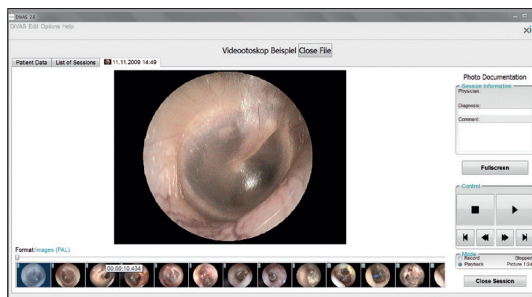

DiVAS Photo Documentation module

An unlimited number of photos can be created during a session. Next, these can be evaluated, compared, deleted, exported, archived or printed individually or in the form of a slideshow.



IMAGE AND VIDEO MANAGEMENT IN THE INTEGRATED OR



Everyday clinical practice is becoming increasingly complex, and novel technologies are becoming increasingly important. To properly perform examinations and interventions, it is essential that comprehensive image information is available at the right time and in optimum quality.

For this purpose, XION offers an extremely innovative and effective solution for data transmission. The XION System provides facilities that ensure that image and video data can be transmitted latency-free and lossless both inside and outside the operating room.

Digital viewing systems have become indispensable in modern operating theatres. XION provides the platform for image and video management, image and video documentation and streaming in the OR. A wide range of different video sources can be controlled centrally from a single workstation. Images, videos and patient data can be individually combined to obtain a clear presentation on a large screen.

The image and video data transmission process is performed by means of standardized network technology, whereby modularly expanding and scaling the systems is easy. XION thus offers a future-oriented video-over-IP system.

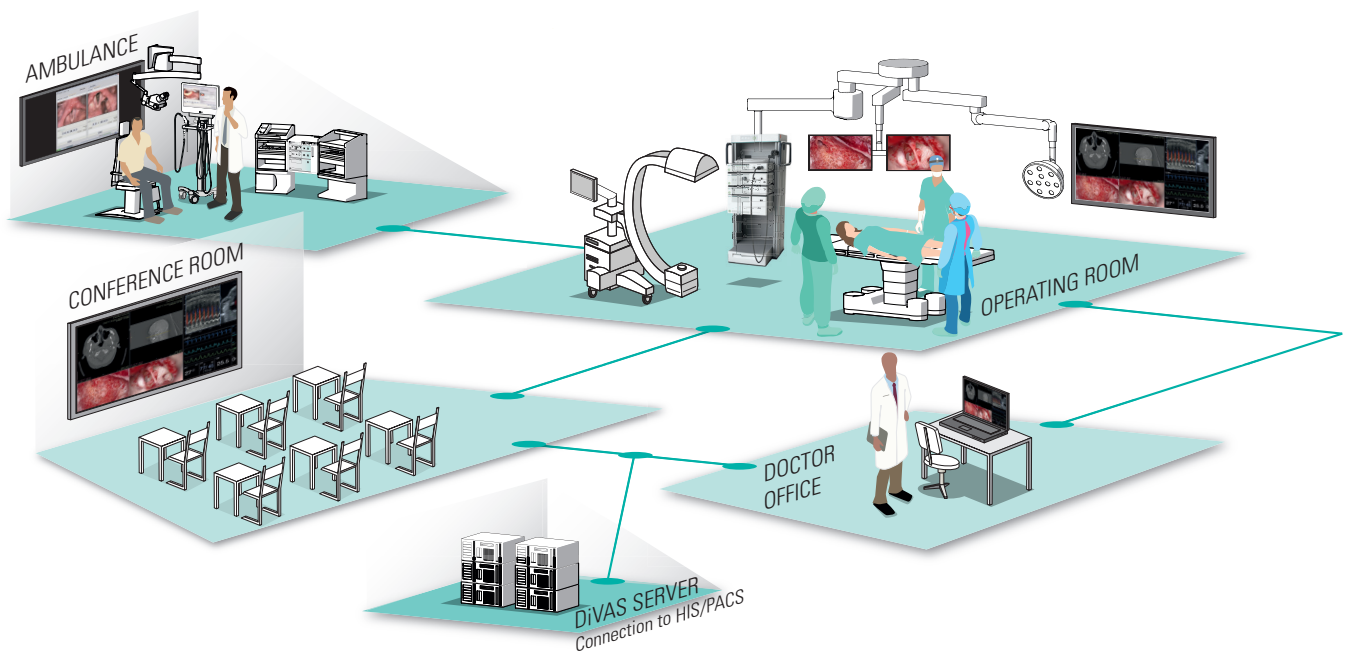

DiVAS NET

DiVAS NET provides automatic, central data backup with access from any workstation. This ensures that clinical staff is provided with relevant image, video and patient information so that work processes are effectively optimised.

High-quality 2D and 3D images and videos with resolutions of up to 4K are made available in the operating theatres and outpatient departments at all times for performing precise and safe interventions and examinations. This provides optimum support for training and further education. Integration into the HIS and PACS is possible at any time for efficient, fast and secure data exchange.

DiVAS Live

If a second opinion is required during a surgical intervention, this can be done via a virtual path. The medical colleague/chief physician who is called no longer needs to go to the OR, but can connect into the operating theatre or overview camera from any workstation and can discuss an issue with the active operating theatre personnel. In the same way, data and images can be transmitted into lecture and convention halls as well as meetings or conference rooms.



Degree of protection	IP20
Protection class	I
Power supply	100 V–240 V 50/60 Hz
Weight	3,8 kg
Dimensions (W x H x D)	350 mm x 76 mm x 365 mm
Operating temperature	+10°C – 40°C
Storage and transport temperature	- 10°C – 60°C
Output interfaces	
Video	2 x DVI-D, 4 x 3G-SDI
	VideofORMAT 2D:
	1080p@60Hz
	2160p@60Hz (only via 4 x 3G-SDI)
	Video formats 3D:
	1080p@60Hz (line-by-line)
	1080p@60Hz (side-by-side)
	1080p@60Hz (simultaneous)
Audio	1x line out, 3.5 mm stereo jack
Controlling external recording devices	2x 3.5 mm mono jack
Input interfaces	
Applied parts	1x Spectar applied part (camera head / video endoscope)
Audio	1 x Audio
Control	1x Footswitch
Power supply	IEC connector
Other	
Controller, service	1 x USB type B
Potential equalization	
Applied standards	
	IEC 60601-1
	IEC 60601-1-2

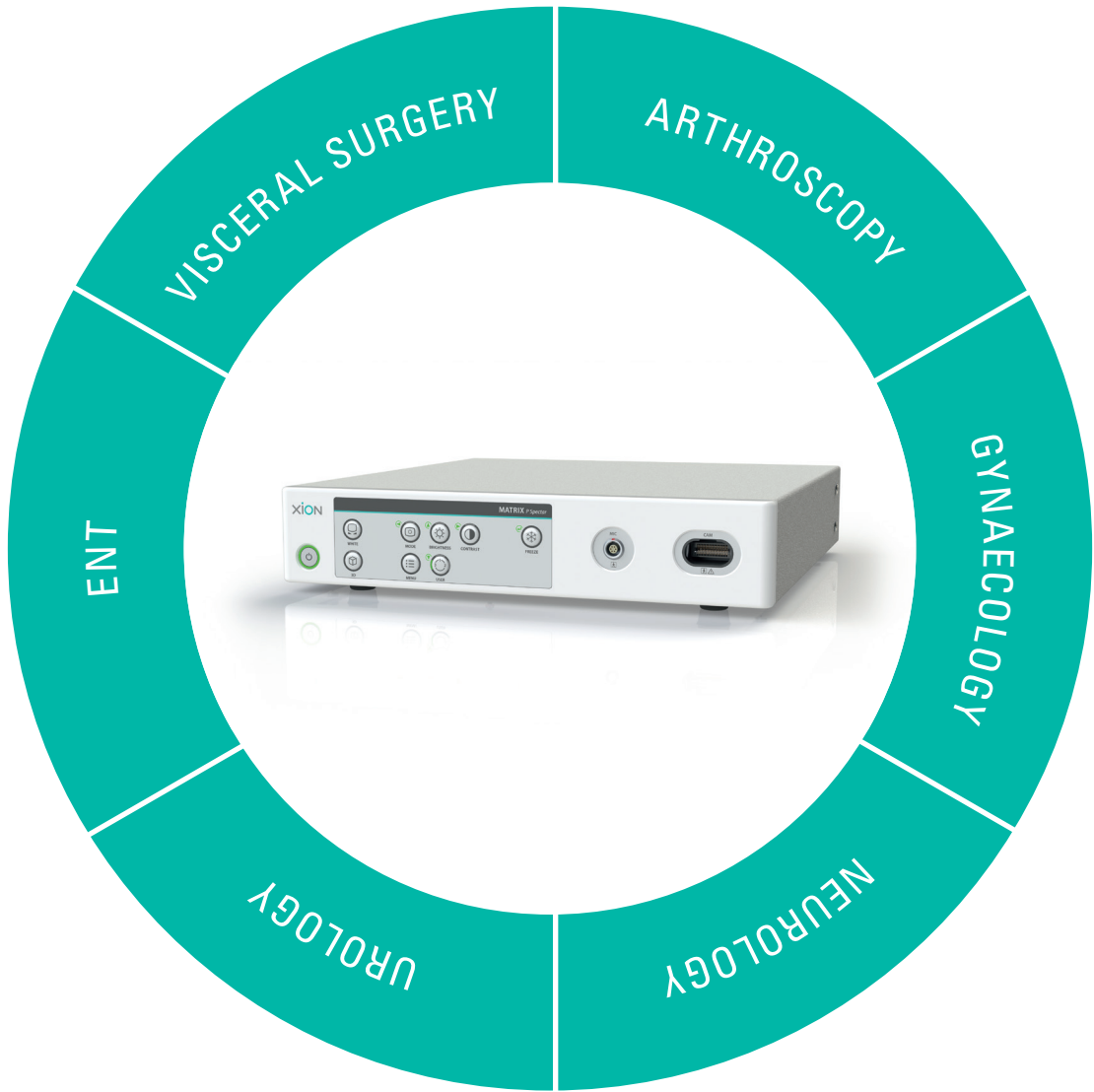



Everything from one source: Endoscopy systems since 1991

XION develops and manufactures devices, optics and instruments for ENT, arthroscopy, laparoscopy and hysteroscopy. Our close collaboration with leading hospitals provides the environment that favours the creation of practical and user-friendly system solutions. Well-founded interdisciplinary competence in the fields of precision mechanics, optics, electronics and software are the basis upon which we set new standards in endoscopy. All products are manufactured at our headquarters in Berlin and sold worldwide through an international network of branches and dealers.



XION GmbH Pankstr. 8 13127 Berlin Germany
Fon +49(0)30-47 49 87-0 Fax +49(0)30-47 49 87-11 Email info@xion-medical.com
www.xion-medical.com www.spectar.xion-medical.com